

Austrian Technological Expertise in Transport



Focusing on:
Hybrid and Electric Vehicles



Volumes already published:

- Austrian Technological Expertise in Transport – Focusing on
- Volume 1 Hydrogen and Fuel Cells – Vienna, Dezember 2007 (deutsch/english)
 - Volume 2 Transport Fuels – Vienna, May 2008 (english)
 - Volume 3 Ausgewählte Projekte aus dem Strategieprogramm Intelligente Verkehrssysteme und Services – Vienna, August 2008 (deutsch)

IMPRINT

Owner, publisher and media proprietor:
Austrian Federal Ministry for Transport, Innovation and Technology – BMVIT
A-1010 Vienna, Renngasse 5

Responsible for content:
Unit for Mobility and Transport Technologies
Head of Department: Evelinde Grassegger
Deputy Head of Department: Andreas Dorda

Editorial staff:
Austrian Agency for Alternative Propulsion Systems (A3PS)
Andreas Dorda, Bernhard Egger, Stefan Herndler, Gabriela Telias
Tech Gate Vienna, Donau City Strasse 1, A-1220 Vienna

Production:
Projektfabrik Waldhör KEG
A-1180 Vienna, Währinger Strasse 121/3

Photos and illustrations:
BMVIT project partners, AVL List GmbH, arsenal research GmbH, G. Brasseur,
Magna Steyr Fahrzeugtechnik AG & Co KG, Technisches Museum Wien,
Wiener Linien GmbH & Co KG, Projektfabrik Waldhör KEG

published in October 2008 (1000 copies)
reprinted in January 2010 (1000 copies)

TABLE OF CONTENTS

Preface	5
Editorial	6
Review article on hybrid and electric vehicles.....	8
A3-Projects	40
A3plus-Projects	54
EU-Projects	58
Austrian institutions in the field of hybrid and electric vehicles.....	62
Contacts and information.....	63



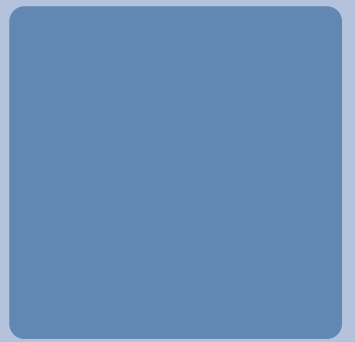
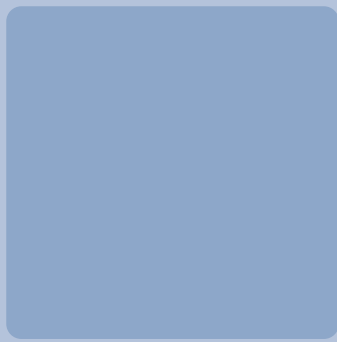
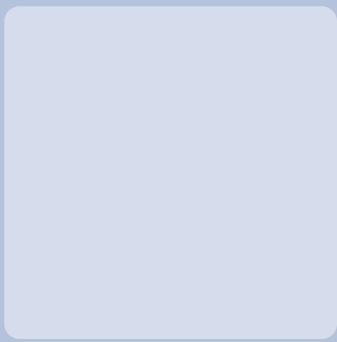

PREFACE

Hybrid and electric vehicles have become a key driver in achieving sustainable mobility by reducing pollutants, greenhouse gases and noise, and in securing the competitiveness of the transport industry. Austria's successful automotive industry includes some of the biggest supply-side companies worldwide. With 175,000 employees, it is strongly involved in the engineering and production of drivetrains. Innovation is a key success factor in benefiting from opportunities in the emerging breakthrough of alternative propulsion systems.

The Austrian Federal Ministry for Transport, Innovation and Technology (BMVIT) has therefore set up the Technology Promotion Programme A3 (Austrian Advanced Automotive Technology), funding 86 research and demonstration projects for the development of alternative propulsion systems and fuels. In the new A3plus programme, 6 out of 17 R&D and 2 out of 3 demonstration projects deal with hybrid and electric vehicles, reflecting the increased importance of the electric drivetrain replacing or complementing the internal combustion engine.

Global challenges such as reducing emissions of pollutants and greenhouse gases led to ambitious goals and mandatory national and EU targets for emissions standards, energy efficiency and security of energy supply. International co-operation is a key success factor in meeting these goals. Austria therefore cooperates strongly with EU technology platforms, FP7 partners and the IEA Implementing Agreement „Hybrid & Electric Vehicles“. The Austrian Agency for Alternative Propulsion Systems (A3PS) is an important instrument for international networking and co-operation between industry, universities, research institutes and the BMVIT with these international partners.

This brochure gives an overview of hybrid and electric vehicle technology, presents Austrian R&D activities in the field of hybrid and electric vehicles, energy storage technologies and electronic control systems, and gives an impression of the high level of expertise in Austrian industry and R&D institutions in the engineering and manufacture of these vehicle components and products.

Austrian Federal Ministry for Transport, Innovation
and Technology

EDITORIAL

This publication constitutes the fourth volume in the series „Austrian Technological Expertise in Transport“, providing a comprehensive overview of R&D projects and research institutions in Austria. Volumes 1 and 2 covered the topics „Hydrogen and Fuel Cells“ (published in December 2007) and „Transport Fuels“ (published in May 2008). Volume 3 presents selected projects from the Technology Promotion Programme „Intelligent Transport Systems and Services“ covering transport telematics, the railway system and rail and automotive propulsion technologies (published in August 2008).

This booklet presents Austrian R&D results and institutions in the field of hybrid and electric vehicles, energy storage technologies and electronic control systems, ranging from national technology promotion programmes to EU and international projects with Austrian participants. The following review article provides a compact and balanced analysis of technological trends in the electric drivetrain and hybrid and battery technologies, before presenting the results of Austrian national and international projects.

The review article is produced jointly by the Austrian Federal Ministry for Transport, Innovation and Technology (BMVIT) and members of the Austrian Agency for Alternative Propulsion Systems (A3PS). The latter promotes the development and deployment of alternative propulsion systems and fuels, supporting Austrian research institutions in their technological development projects and acting as a platform for national and international activities. Within A3PS, the BMVIT cooperates with industrial and research partners in order to offer a broad portfolio of additional support activities for Austrian research institutions. Pursuing the principles of modern technology policy, the BMVIT is convinced that public authorities can facilitate the development of new technologies far beyond financial contributions by analysing technological trends, developing interdisciplinary R&D co-operations and demonstration projects, creating efficient framework conditions, promoting innovation, and through international networking and marketing for Austrian technological expertise and for the engineering and product know-how of A3PS members, as well as by representing their interests in EU or IEA committees.

Fostering innovation for efficient and sustainable transport systems, the „Mobility and Transport Technologies“ unit at the BMVIT has been supporting research, development and demonstration projects for many years. The Technology Promotion Programme A3 (Austrian Advanced Automotive Technology) was launched in 2002, with the aim of securing the competitiveness of the Austrian supply industry and of solving urgent environmental problems through clean and innovative vehicle technologies.



A3 concentrates on highly innovative research projects with increased development risk, which receive higher levels of funding than is usually provided by technology promotion programmes. The goal is to achieve real technology breakthroughs and not incremental improvements to existing technologies. Grants are awarded according to the competitive principle, through calls for proposals. A3 covers the entire innovation cycle and offers funding from basic research to demonstration projects. Furthermore, projects are funded which adapt education and training to the new requirements and create an adequate supply of well-qualified human resources. Another pillar of the programme supports international networking, mobility and co-operation between researchers. A3 strives for synergies from interdisciplinary co-operation between industry, universities, research centres and between suppliers and users of technologies in joint R&D projects.

Four A3 calls for proposals for projects developing alternative propulsion systems and vehicle electronics, materials research and production technologies were carried out between 2002 and 2006. The focus was on road vehicle technologies, but opportunities for alternative propulsion systems in rail and waterborne vehicles were investigated as well. From the 152 proposals submitted, 77 projects were adopted and realised following evaluation, with a funding budget of EUR 20.2 million (out of a total budget of about EUR 40 million).

Lighthouse projects are another instrument of the BMVIT to support the market introduction of new vehicle technologies. Complementary to the A3 calls, the BMVIT uses lighthouse projects to support large pilot and demonstration projects, bringing together the providers and users of technologies as well as all other relevant stakeholders in a single project, proving the successful operation of new technologies, moving to optimise them under real-life conditions and to prepare the public for new vehicle technologies. The single focus of lighthouse projects is the market introduction of alternative propulsion systems and fuels. In two calls for lighthouse projects 25 proposals were submitted in 2005 and 2006.

In a two-stage evaluation process, 8 projects were selected. The total budget was EUR 7.4 million, with a funding budget of EUR 3.3 million.

The A3 technology programme expired in December 2006. The BMVIT has therefore developed the follow-up programme A3plus, covering all modes of transport, with the following research areas:

- > Alternative drive systems and their components
- > Alternative fuels
- > Innovative energy storage concepts
- > Development and promotion of necessary supply infrastructures for refuelling and the use of alternative drive systems
- > Concepts for embedding alternative drives in the total vehicle design

In the first A3plus call for proposals, with a funding volume of EUR 7 million, 17 R&D projects and 3 lighthouse projects were selected for funding in 2007, among them 8 on hybrid and electric vehicles.

The BMVIT complements these national activities with intensive international co-operation through partnerships with the European Union, its member states, industry and research institutions in the 7th R&D Framework Programme, the FCH JTI (Fuel Cells & Hydrogen Joint Technological Initiative), the EU Technology Platforms ERTRAC, FCH and BIOFUELS, and the International Energy Agency (IEA).

The IEA Implementing Agreement „Hybrid & Electric Vehicles“ is of special relevance for this booklet on hybrid and electric vehicles, energy storage technologies and electronic control systems. The strategic importance of this international R&D co-operation is based on its worldwide participation with the member states Austria, Belgium, Canada, Denmark, France, Italy, the Netherlands, Sweden, Switzerland, Turkey and the United States, necessary in facing up to global challenges like climate change and achieving a sustainable energy and transport system.

Evelinde Grassegger
Andreas Dorda

Unit for Mobility and Transport Technologies

- > HYBRID AND ELECTRIC VEHICLES
- > HYBRID ELECTRIC VEHICLES
- > ELECTRIC VEHICLES
- > CHARGING INFRASTRUCTURE AND SUSTAINABLE ENERGY FOR ELECTRIC PROPULSION
- > ENERGY STORAGE
- > ELECTRIC DRIVES
- > INTERNAL COMBUSTION ENGINES AND TRANSMISSIONS FOR HYBRID POWERTRAIN SYSTEMS
- > CONCLUSION

ACKNOWLEDGMENTS

The creation of a brochure of this size and complexity could not have been accomplished without the gracious help, collegial cooperation, and very hard work of many people. At this point we want to thank all those people for their work and contributions to the brochure.

Brasseur, Georg	Graz University of Technology – Institute of Electrical Measurement and Measurement Signal Processing
Brauner, Günther	Vienna University of Technology – Institute of Electrical Power Systems and Energy Economics
Cifrain, Martin	Kompetenzzentrum – Das virtuelle Fahrzeug Forschungsgesellschaft mbH
Conte, Fiorentino Valerio	arsenal research
Dorda, Andreas	BMVIT / A3PS
Dörr, Elisabeth	arsenal research
Fafilek, Günter	Vienna University of Technology – Institute of Chemical Technologies and Analytics
Geringer, Bernhard	Vienna University of Technology – Institute For Internal Combustion Engines and Automotive Engineering
Kriegler, Wolfgang	Magna Steyr Fahrzeugtechnik AG & Co KG
Kronberger, Hermann	Vienna University of Technology – Institute of Chemical Technologies and Analytics
Lichtblau, Günther	Umweltbundesamt
Noll, Margit	arsenal research
Oberguggenberger, Helmut	arsenal research
Pirker, Franz	arsenal research
Pötscher, Friedrich	Umweltbundesamt
Prenninger, Peter	AVL List GmbH
Saricks, Chris	IEA-IA-HEV
Spitzer, Josef	Joanneum Research
Vrabic, Gernot	Vienna University of Technology – Institute of Chemical Technologies and Analytics
Walwijk, Martijn van	IEA-IA-HEV
Winter, Ralf	Umweltbundesamt
Winter, Stefan	Vienna University of Technology – Institute For Internal Combustion Engines and Automotive Engineering

REVIEW ARTICLE ON HYBRID AND ELECTRIC VEHICLES

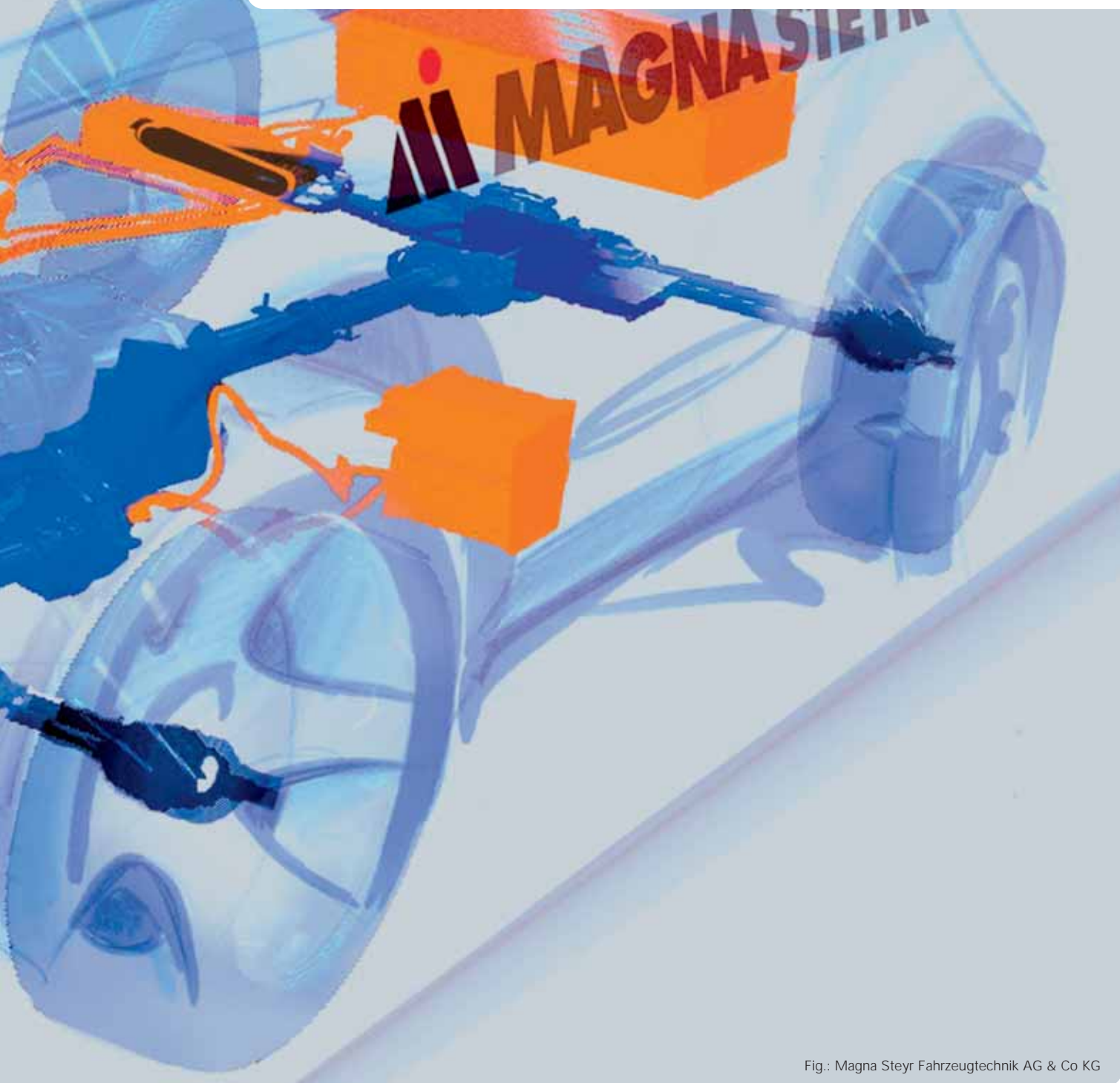

Fig.: Magna Steyr Fahrzeugtechnik AG & Co KG

HYBRID AND ELECTRIC VEHICLES

Under the Kyoto Protocol, the European Union (EU) is committed to reduce greenhouse gas (GHG) emissions by 8% within the 2008 to 2012 period, compared to the 1990 level. In March 2007 the EU committed itself to a 20-30% reduction of GHG emissions overall by 2020. Transport-related CO₂ emissions grew by 35% in the EU between 1990 and 2006. Other sectors reduced their emissions by 3% on average over the same period. The transport sector is therefore performing far behind Kyoto targets, seriously hindering the achievement of these targets within the EU.

The share of transport in CO₂ emissions was 21% in 1990 and grew to 28% by 2006. The European Environment Agency estimates that cars are responsible for half of this amount, so 14% of the total CO₂ emissions. The high share of CO₂ emissions reflects the fact that the transport sector is strongly dependent on fossil energy sources. In the EU, oil imports for cars now amount to €140 billion a year, which is about the same value as the entire European car industry generates each year. GHG emissions are expected to rise by 35% by 2010 unless the necessary countermeasures are implemented. According to the European Environment Agency's official inventory report on emissions in 2006, released in June 2008, the transport sector continues to be Europe's worst emitter of GHG.

Against the background of steadily rising GHG emissions, imminent and visible climate change and increasing dependence on energy resources from politically unstable regions, policymakers set ambitious goals to secure energy supply and to reduce GHG emissions, including those from the transport sector. The biofuel directive (COM 2003/30/EC) approved by the

EU in 2003 and the proposed 2008 directive (COM(2008) 30 final) on the use of renewable energy both have the aim of reducing the use of fossil energy in order to bring down GHG emissions and at the same time lower the European dependence on oil imports.

Besides substituting fossil fuels with biofuels, a noteworthy increase in the energy efficiency of vehicles is necessary to achieve these goals. From a wide range of technical options, Hybrid Electric Vehicles (HEVs) and Electric Vehicles (EVs) both offer improved energy efficiency together with added value in terms of emissions and noise. In order to optimise the ecological balance sheet, electricity obtained from renewable sources is promoted as possible alternative fuel for powering vehicles.

Back in 1995, a common strategy to reduce CO₂ emissions from passenger cars (COM (2005) 261) was presented by the EU Commission, with the target of reducing average CO₂ emissions from new passenger cars to a level of 120 grams CO₂ per kilometre (g CO₂/km) by 2012, which corresponds to a consumption of about 5 litres gasoline or 4.5 litres diesel per 100 kilometres. The strategy was based on 3 major approaches:

- > Self restriction from automobile manufactures (1998)
- > Providing consumer information related to CO₂ emissions from passenger vehicles
- > Promoting lower fuel consumption through fiscal measures

The evaluation of the approach revealed that the voluntary agreement has so far not met the designated targets, as figure 1 illustrates.

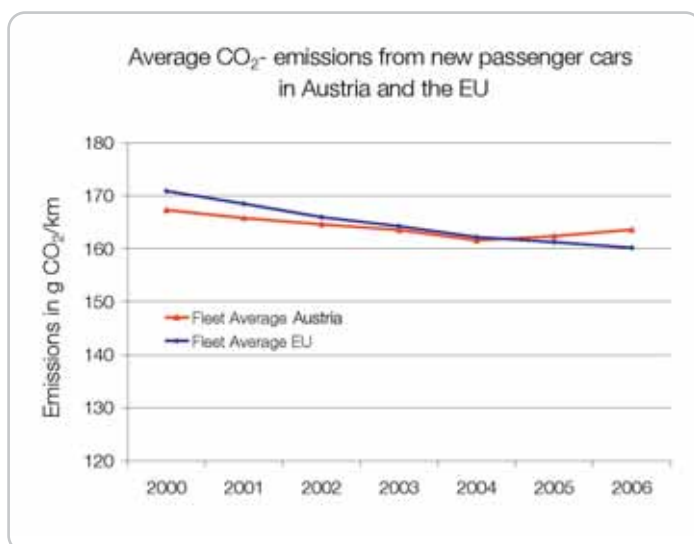

Figure 1: Trend in average CO₂ emissions from new passenger cars in Austria and the EU from 2000 to 2006

To address this dilemma, in 2007 the European Commission (EC) presented a proposal for binding targets (INI/2007/2119) including penalties for manufacturers not meeting the target of 130 g CO₂/km through efficiency improvements in (combustion) engines by 2012. Additional reductions (10 g CO₂/km) are to be obtained through improvements in vehicle technology, for instance by using efficient air-conditioning systems, light tyres and additional blending of biofuels. This initiative is planned to be finalised within the year 2008.

Regarding the fiscal measures of the strategy from 1995, Austria amended the „Normverbrauchsabgabegesetz“ (NoVA) - the legal basis for levying duty when newly-registered vehicles are accredited - for the first time in July 2008. In consequence, environmentally friendly vehicles are being promoted by reduced taxation. In addition, fiscal penalties are being imposed on fuel-intensive, conventionally-powered passenger cars, depending on their CO₂ emissions.

To sum up, many existing incentives and directives favour „green cars“. Some aim for greater efficiency, while others intend to substitute fossil fuels with renewable fuels. Beyond that, the transport sector is facing additional challenges concerning airborne pollutants, mainly in densely populated areas. Future mobility needs to meet strict emissions standards, as are being imposed by European exhaust emission standards (EURO classes). Emissions standards are defined in a series of European Union directives staging the progressive introduction of increasingly stringent standards. Regulated pollutants covered by the standards are carbon monoxide (CO), hydrocarbons (HC), nitrogen oxides (NO_x) and particulate matter (PM).

While substitution with biofuels primarily addresses climate change and the dependence on oil imports, hybridisation and electrification of vehicles have the potential to increase energy efficiency, reduce fossil fuel consumption by electricity from renewable energy sources and decrease emissions of airborne pollutants, as well as noise.

A HEV is a combination of a conventional propulsion system and an electric drivetrain, including an electrical energy storage system. Depending on the level of hybridisation, vehicles can be classified into various subgroups. A detailed description of the various hybrid systems, including their advantages and disadvantages, can be found in the section on HEVs.

HEVs and EVs are driven partially or even totally by electrical motors powered by on-board energy storage devices. The by far most important storage devices are batteries, but also supercaps and fly-wheels are available. The commercial success of these vehicles with their potential for reduction of GHG emissions will be determined mostly by the technological development of batteries regarding their expected energy density, power density, cost, lifetime and safety.

Whereas in the beginning mainly Japanese OEMs used hybrid technology, worldwide manufacturers now realise the importance of this technology. At the moment, gradual electrification of vehicles is already underway amongst European car manufacturers. Many of them recently started to integrate automatic start/stop systems in their series production (e.g. Citroën C3, BMW Series 1 and Series 3 since 2007).



Considering Japan and the United States of America (US), hybrid technology has been available to the general public since 1997. The Toyota Prius was the first mass-produced and commercially marketed hybrid car, selling 18,000 units in its first year. It is still a popular car today; and thanks to a variety of celebrity endorsements it demonstrated that the public is ready for alternative transport. Worldwide sales of Toyota's hybrid vehicles exceeded 1,000,000 by April 2008.

Generally the market for HEVs is very dynamic and growing fast. The US market is especially attractive for alternative propulsion systems. Figure 2 shows the cumulative sales of passenger HEVs that are commercially available in the US. Within the last decade the HEV market share of Light Duty Vehicles (LDVs) sales has been rising as well. At the moment the Japanese and US hybrid markets are the most important, in terms of total sales and market share (figure 3), but the growth rate of the HEV market in Europe is considerably higher than in Japan and the US and therefore seems promising for the future.

Compared to the total vehicle market sales of HEVs are limited. However, worldwide car manufacturers have realised the importance of the hybrid technology and are intensively investigating the areas of power electronics and on-board energy storage.

While HEVs being offered on the market do not have any range restrictions compared to conventionally powered vehicles, EVs suffer from what initially appeared to be rather small achievable ranges. Common ranges for fully electrically powered vehicles are around 70 to 150 kilometres. However, some manufacturers of lithium-ion battery-powered vehicles in the high-priced segment claim up to three times higher vehicle ranges. Battery prices at the moment are still very high in terms of €/kWh, which is in part due to small production volumes and low market share. That said, current developments in the battery segment seem to be promising.

Looking at average distances per trip and average daily mileage in practice puts the range problem of electric vehicles in another perspective. In Austria roughly 97% of all trips and 80% of all daily mileage are less than 100 kilometres. Commuters in Austria cover a daily distance of only 15 kilometres on average. Taking these figures into account, there are various possibilities for electric vehicle applications. Nevertheless, further improvements in battery technology still need to be realised in order to enhance the market.

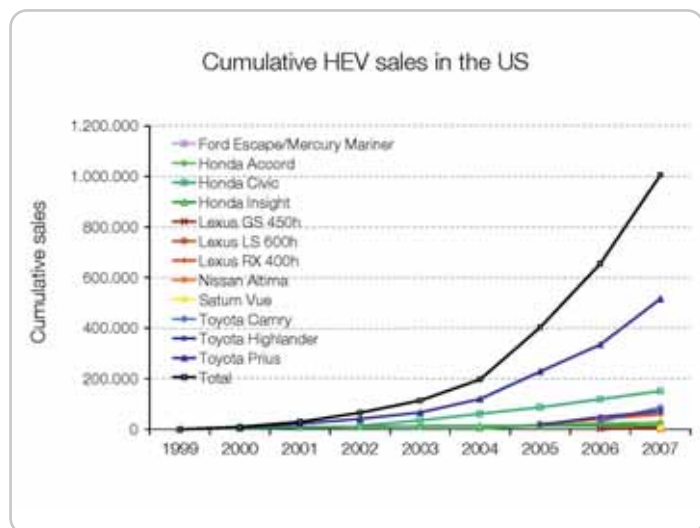

Figure 2: Cumulative HEV sales in the US

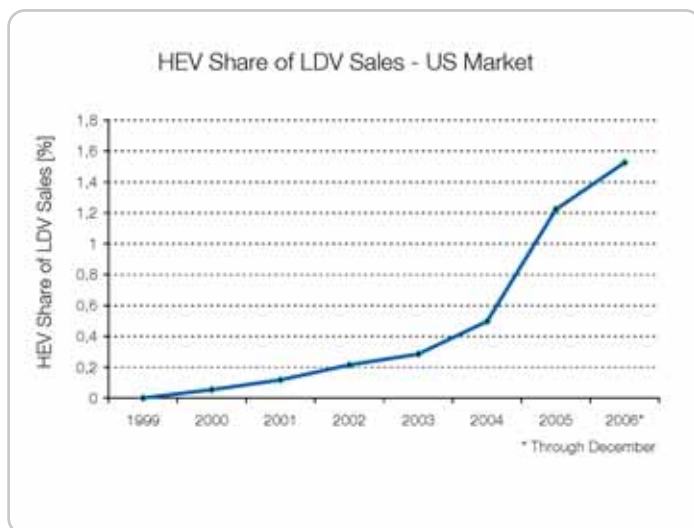

Figure 3: Share of hybrid and electric vehicles in light duty vehicle sales in the US

Electric vehicles offer, apart from their high energy efficiency, the advantages of no local emission of any air pollutant and far lower noise emissions from the whole drivetrain than conventionally powered vehicles. In urban driving applications these are two major advantages of the electric vehicle over vehicles powered by internal combustion engines (ICEs). Given that the problems of local noise and air pollution require action, introducing electric mobility can be seen as a great opportunity. Low-emission zones are being established all over Europe, where polluting vehicles are partially restricted from entering or charged a fee. Particulate matter, ozone and nitrogen oxides (NO_x) generally create great concern amongst authorities. Electric vehicles, being emission-free, will clearly have an advantage in this regard. Major cities like London are either currently planning or carrying out field studies with electric fleets. HEVs that can be electrically operated in city traffic offer similar benefits.

Although electric vehicles cause no direct emissions, it is also necessary to consider energy production aspects. If the electric energy generated from renewable sources, the overall balance of emissions is advantageous; if using electricity from conventional coal-fired plants, electric vehicles perform only a little better in terms of energy efficiency and overall GHG emissions compared with existing fuel-efficient vehicles. This topic will be further discussed in the section on charging infrastructure.

Due to the overall high efficiency of fully electrically powered vehicles, less energy is consumed compared to vehicles equipped with conventional powertrains. This fact not only gives a clear ecological advantage to electric vehicles, but also massively affects running costs, thus making them also more economical. As energy prices are projected to increase continuously, running costs will definitely become of greater importance for customers, and electric propulsion systems can assist maintaining individual mobility in the future.

To sum up, HEVs are technical options for the future that can contribute meeting the challenges for road transport by reducing CO₂ and pollutant emissions and increasing the energy efficiency.

Despite the positive effects of introducing hybrid and electric vehicle technology to address policy objectives, economic developments and the limited nature of fossil fuel resources, these promising technologies still have to overcome a number of hurdles, especially regarding the electric energy storage system.

Over a number of years, the statutory framework has reflected growing interest in the area of alternative propulsion and in vehicle technology, introducing biofuels and launching RD&D projects for hybrid and electric vehicles. This interest is now further increased due to recent surge in oil prices.



HYBRID ELECTRIC VEHICLES

Hybrid electric vehicles (HEVs) are a first step towards electric powertrains, and generally consist of a conventional internal combustion engine (ICE) combined with an electric motor. Their main advantage is improved overall energy efficiency for the vehicle in urban driving conditions and therefore a decrease in fuel consumption and emissions, whilst simultaneously guaranteeing appropriate range and performance.

HYBRID ELECTRIC VEHICLE CONCEPTS

Generally HEVs can either be classified depending on the arrangement of their components or on their degree of electrification. According to the component arrangement, it is possible to distinguish between four vehicle concepts.

- > Integrated starter generator (ISG) concept, the ICE is directly connected to a generator and the driveshafts,
- > Parallel hybrid concept, an additional clutch separates the ICE from the electric machine and the driveshafts,
- > Series hybrid concept, the ICE powers a generator and the driveshaft is electrically driven and
- > Combined hybrid concept, the ICE can mechanically transfer the power to the wheels as well as electrically through a generator and the electric machine.

For examining the functions of HEVs, it is more reasonable to classify HEVs according to their degree of electrification (figure 1) as it is done in the following description.

Micro HEVs mark the first step towards electrification of the transport sector, They are conventional vehicles integrating a new technique, known as the start/stop system. This system automatically shuts down the ICE when the vehicle stops and restarts it when the accelerator is pressed. Micro HEVs offer no option for an electric drive or electric acceleration (boosting). Their main advantage is that they can be realised with only slightly increased costs. On the other hand they contribute to a limited extent in decreasing CO₂ emissions. Available Micro HEVs are for example the BMW 1 or the Citroën C3 Stop & Start. Since this „light“ hybrid concept can be adapted easily to a conventional powertrain it is expected that many manufacturers will introduce this system in the near future.

Mild HEVs integrate an electric motor for assistance during acceleration (boosting), which allows a smaller and more efficient ICE. Furthermore, the electric motor acts in reverse as a generator when the car is braking, recovering the kinetic energy (recuperation) and charging the battery. Since Mild HEVs do not allow electric driving, this concept similarly achieves only small improvements in fuel demand compared to conventional powertrains. However, they allow downsizing of the ICE without any reduction in performance or comfort, with acceptable extra cost. A number of manufacturers, such as Honda, Citroen, Peugeot and Mercedes-Benz, are looking specifically at the development and market introduction of Mild HEVs. Honda, for instance, has launched the Honda Civic IMA (Integrated Motor Assist) and the Honda Insight IMA, and Peugeot has developed the 307 HDi Hybrid.

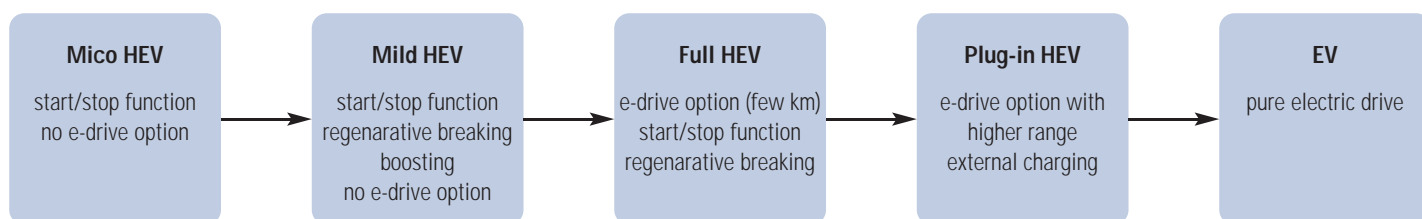

Figure 1: Electric-hybrid powertrain concepts based on their degree of electrification

Full HEVs (parallel hybrids) provide pure electric propulsion at low speeds since both the ICE and the electric machine are attached to the driveshafts and the wheels of the vehicle. Due to the pure electric driving at low speeds, the benefits of Full HEVs are mainly exhibited in city driving cycles. In such cases fuel consumption and thereby also emissions can be reduced by up to 30%. At the same time, a better driving performance can be achieved, compared to a conventional powertrain. At medium or high speeds, the full hybrid electric powertrain contributes to energy efficiency improvement by operating the ICE in the range of highest efficiency and recharging the battery in case more power than needed for traction is produced by the ICE.

The concept of the combined hybrid offers more flexibility in power distribution and is implemented for example in the well known Toyota Prius. Production of other HEVs applying this concept have been or are currently being launched for example by Lexus (Lexus LS 600h, Lexus GS 450h and RX400h), Chevrolet (Silverado Hybrid, Tahoe Hybrid), Ford (Mariner Hybrid, Escape Hybrid), Mazda (Mazda Tribute HEV) and Nissan (Altima Hybrid). Some of these products are only available in Japan or the US. However, it can be expected that within the next years Porsche, Saab, Land Rover and VW will also launch Full HEVs. The number of Full HEVs currently under development or in testing shows the relevance of this vehicle concept and its potential.

As an advanced concept series hybrids rely on electric propulsion with an ICE for range extension. The ICE is not connected to the car's wheels and is only used to generate electricity, which powers the electric machine and charges the

battery. This ICE is much smaller than those in conventional cars, and it usually operates in its most efficient range and at constant speed. A series hybrid can also be realised with a fuel cell instead of the ICE. This hybrid concept clearly has the highest potential, since it exhibits high energy efficiency through electric propulsion whilst at the same time offering suitable range. Several manufacturers have therefore started to investigate series hybrids. Prototypes have been developed by Volvo (ECC), for example, and GM is promoting series concepts with its E-flex programme.

Plug-in HEVs (PHEVs) similarly provide significantly increased electric ranges compared to present-day HEVs, since the battery can also be charged from the grid. In order to accommodate this additional energy PHEVs usually have a bigger battery pack. The distances these vehicles can drive on electric power vary widely, ranging in total from about 20 km to 80 km. Due to the additional costs for the battery pack, the PHEV is only starting to appear on the market, although there are several initiatives investigating PHEVs, especially in the US. Prototypes have been developed by Audi (Metroproject Quattro), Chevrolet (Volt Concept) and Toyota (Prius PHV).

The various configurations of HEVs mentioned before can be classified with the help of electric parameters as well. Mainly the used voltage, power and amount of the energy stored or a ratio between them are used to classify HEVs.

Table 1 gives an overview of HEV configurations ranging from the Micro HEV to the battery electric vehicle (BEV) together with the corresponding relevant parameters.



	Power/Energy	Energy [kWh]	Power [kW]	Voltage [V]
Micro HEV	>60	<0,6	<6	12
Mild HEV	30 - 80	<1	<13	12 - 42
Full HEV	20	<4	20 - 100	>150
PHEV	7 - 12	5 - 20	<80	>200
BEV	2 - 3	>15	20 - 60	Still to be determined

Table 1: Identification parameters for HEV configurations

TECHNOLOGICAL CHALLENGES

Given the focus on maximum reduction of fuel demand and emissions, the significance of electric propulsion will increase further. Different constraints have to be considered for the development of new concepts and their broad market introduction. From the ecological, economical and legislative point of view, vehicles need to offer maximum energy efficiency, with lowest possible CO₂ emissions and fuel demand, to be in line with current and future regulations.

The integration of both conventional and electric powertrain components significantly increases the weight of the entire powertrain. From the customers' point of view, the new concepts have to provide at least the same performance and drivability as conventional vehicles. In addition the costs have to be kept as low as possible, since higher costs for additional powertrain components (e.g. electric machine for hybrids, energy storage system) hinder broad market introduction. The development of highly integrated as well as highly optimised subsystems is therefore essential for the launch of competitive products.

In case of PHEVs, an appropriate charging infrastructure is also required, which has a knock-on impact on grid management and the energy supply. This leads to a complex set of issues that have to be considered and integrated in the development of new vehicles. Table 2 summarises the main research topics relating to HEVs.

Batteries are one of the key components for electric and hybrid electric propulsion, since they define the performance and range of the vehicle. Almost all HEVs initially sold used nickel-metal hydride batteries (Ni-MH); this battery type has been successfully implemented in Mild and Full HEVs. Current battery technologies have shown major progress in recent years, but with regard to HEVs the costs, weight, safety and life time of the batteries still need to be improved significantly. Lithium-based batteries, in particular, offer good potential for advanced HEVs, but some cell types still arouse major safety concerns. R&D efforts now strongly focus on lithium-ion batteries (Li-ion) which are expected to be implemented in the next generations of HEVs and PHEVs, but development efforts are still required at both cell and systems level. In general, it needs to be appreciated that selecting the appropriate cell type – as well as the design of the battery management system – depends on the given application. Further efforts are also required to realise highly efficient and optimised systems based on low-cost components and highly integrated subsystems.

Concerning the PHEV concept, additional issues to be considered are the availability of the charging infrastructure and the additional costs caused by integrating more powerful electric powertrains and larger batteries.



Research topic	Required improvement	Enablers
Energy storage	<ul style="list-style-type: none"> • Cost and weight reduction • Higher safety at cell and system level • Higher energy density for high e-range • Longer life time • Thermal management 	<ul style="list-style-type: none"> • New/improved materials • Standardised test procedures
Electric components (e-machines, converters, control, high voltage systems)	<ul style="list-style-type: none"> • High efficiency • Low weight • High integration and modularisation of electric powertrain • Standardisation of components • Low-cost components • Safety concepts 	<ul style="list-style-type: none"> • Integrated approach to powertrain development • Adjustment of the electric powertrain components for a highly optimised system • New components, e.g. switches, fuses etc.
ICE	<ul style="list-style-type: none"> • Optimised and downsized ICE 	<ul style="list-style-type: none"> • Integrated approach to powertrain development
Charging infrastructure	<ul style="list-style-type: none"> • Establishment and implementation of appropriate charging concepts • Standardisation 	<ul style="list-style-type: none"> • New business models • Infrastructure upgrade (on individual and public level) • Cost
Energy generation and distribution	<ul style="list-style-type: none"> • Providing CO₂-neutral energy for green road transport • Efficient and safe distribution 	<ul style="list-style-type: none"> • Increased share of renewable energies • Intelligent grid management

Table 2: Summary of research topics related to electric and hybrid electric vehicles, their required improvement and their main enablers



ELECTRIC VEHICLES

In the late 1890s, electric vehicles (EVs) outsold gasoline cars by ten to one. EVs dominated the roads and dealer showrooms. Some automobile companies, like Oldsmobile and Studebaker actually started out as successful EV companies; the transition to gasoline-powered vehicle production took place later. In fact, the first car dealerships were exclusively for EVs.

Early production of EVs, like of all cars, was accomplished by hand assembly. In 1910, mass production of gasoline-powered cars was achieved with the motorised assembly line. This breakthrough in the manufacturing process killed off all but the most well-financed car builders. The infrastructure for electricity was almost non-existent outside of city boundaries – limiting EVs to transport within the city. Another contributing factor to the decline of EVs was the addition of an electric motor (i.e. the cranking motor) to gasoline-powered cars by Cadillac in 1912 – finally removing the need for the difficult and dangerous crank to start the engine. Due to these factors, production of EVs stopped by the end of World War I, and they became niche vehicles – serving as taxis, trucks and delivery vans.

The Lohner Porsche exhibited for the first time in the World Exhibition of Paris 1900 surprised the automobile world and became an authentic novelty for the automobile fans of that time (figure 1).

The success of this innovating design catapulted engineer Dr. Ferdinand Porsche, the draftsman of this EV, to fame. 300 Lohner Porsches were produced at that time. Later on the Lohner Porsche was further developed and became the first HEV. The Lohner Porsche petrol-electric „Mixte“ used a petrol engine rotating at a constant speed to drive a dynamo, which charged a bank of accumulators.



Figure 1: Lohner Porsche

These, in turn, fed current to electric motors contained in the hubs of the front wheels. Therefore there was no need of driveshafts, transmission, gears, straps, chains, or clutch. Due to its extreme simplicity, the transmission operated without losses produced by mechanical friction losses with an impressive efficiency of 83%.

In the late 1960s and early 1970s, there was a rebirth of EVs prompted by concerns about air pollution and the OPEC oil embargo. There have been repeated initiatives by various car manufacturers to establish electric vehicles on the market (e.g. the EV1 from GM, Golf - Citystrome from VW or Peugeot Partner Electrique). In the early 1990s, a few major automakers resumed production of EVs – prompted by California's landmark Zero Emission Vehicle (ZEV) Mandate. These EVs were produced in very low volumes – essentially hand-built like their early predecessors. However, as the ZEV mandate was weakened over the years, the vehicle manufacturers stopped making EVs – Toyota was the last major car manufacturer to stop EV production in 2003. Up until now, however, they have barely had an impact on the market, due to a number of limiting factors, primarily on account of their low range and high battery costs. At present and for similar reasons, several attempts to relaunch these technologies can be observed.

The increasing emissions of CO₂ and high fuel prices on the one hand and technological advances particularly in the field of energy storage on the other hand, have made electric vehicles a progressive and forward-looking concept in this situation as it is today. A wide range of vehicle concepts, both for the two-wheeler and the passenger car segment, have been realised in recent years, demonstrating the advances in and the potential of electric vehicles.

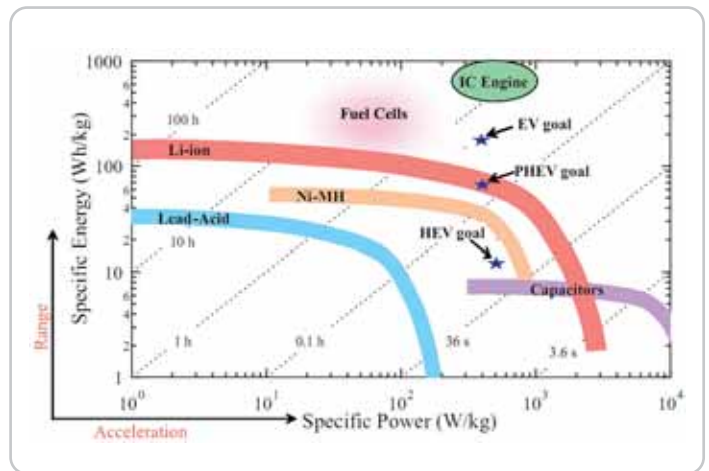

Figure 2: Ragone Plot. The development goals of the US Department of Energy (DOE) with regard to specific energy and specific power for various vehicle concepts are indicated by stars.

CURRENT STATE OF TECHNOLOGY

The great potential for electric vehicles derives from the possibility of reducing dependency on fossil fuels and significantly increasing the efficiency of the drivetrain. Electric drives have a far higher level of efficiency than drivetrains with a conventional combustion engine. Given the current state of the technology, however, these key advantages are set against certain disadvantages, such as poor range, high initial cost and safety aspects of the energy storage systems (table 1).

Constraints imposed by the requirements of the electric vehicle concept, especially regarding the battery storage system, prevented the entering of this technology into the mass market so far. The outcome of past electric vehicle developments mainly resulted in special applications not suitable for the mass market. Current applications range from scooters over vehicles for handicapped people to micro cars with restricted space and drive range. All of these are more or less only suitable for special tasks and needs, not being able to compete in the dominant vehicle segments with large sale figures. The trend nevertheless shows that manufacturers are trying to enter the mass market with competitive electric vehicles. Although manufacturers are quite cautious with forecasts at the moment, customers can expect competitive electric or partially electric vehicles in the forthcoming years. Fleet demonstrations like for instance those in London, Berlin or Munich as well as larger scale projects like the project „better place“ will support the market introduction of electric vehicles with considerably higher sales figures.

Advantages of electric vehicles

- CO₂-neutral system by using renewable energy
- High energy efficiency
- Low operating costs
- Low-noise propulsion system
- Existing power supply grid
- No emission of pollutants at the place of vehicle operation

TECHNOLOGICAL CHALLENGES

The main focus in the development of EVs remains in maximising range, performance and safety, while minimising weight and cost. To that end, it is necessary on the one hand to consider the electrical drive, comprising the electric machine, the converter, the controller and the energy storage unit, as a total system and to develop highly optimised individual components in accordance with these system requirements. Often the individual components are configured for maximum performance, with the ability of the individual components to cope with overload mostly not being taken into consideration, generally resulting in over-dimensioning, higher costs and greater weight in the overall system. For that reason, in order to achieve ideally configured components, the overall system in the vehicle including all relevant components and their reciprocal dependencies needs to be considered as the starting point in developing the individual components. On this basis, a key step can also be taken towards optimising energy management and the control system.

The core component of an electric vehicle is the energy storage system, since it defines the range and performance of the vehicle, but, at the same time, it is the biggest challenge for further improvements of the overall vehicle.

In recent years, nickel-metal hydride (Ni-MH) and above all new lithium-ion (Li-ion) cells have established themselves as very high-performance batteries which already possess sufficient energy density and are thus ready for series applications (figure 2). At the same time, further improvements in Li-ion batteries are needed with regard to weight, costs and especially safety, in order to establish them as an alternative technology for hybrid and electric vehicles.

Requirements of electric vehicles for broad market penetration

- Ensuring adequate drive range
- Safety of the energy storage system
- Widespread availability of the charging infrastructure
- Acceptable charging times for the energy storage system
- Innovative design
- Use of renewable energy resources to provide electrical energy
- Reduction of high initial cost for energy storage device

Table 1: Advantages and requirements for future-proof electric vehicles

MARKET PENETRATION AND MARKET POTENTIAL

The ability of the new technologies to penetrate the market is determined by a number of factors. In addition to environmental policy objectives such as more stringent regulations for the emission reduction of CO₂ and pollutants, factors such as operating costs or procurement costs also play a significant role which also needs to be taken into account when assessing market potential.

Particularly in terms of operating costs, EVs offer a major advantage. A conventional vehicle would need to achieve a fuel consumption of around 1.25 litres per 100 km to match the running costs of around € 225 per year for an EV. For customer acceptance, however, some additional factors such as the legislative framework conditions (more demanding CO₂ limits, etc.), incentive systems (driving bans for conventional propulsion systems in sensitive areas, reduced insurance for alternative propulsion systems, etc.), safety, driving behaviour or design are decisive.

The current trend in the electric vehicle market can be subdivided into two directions, in terms of vehicle types. On the one hand, there are the light electric vehicles, operating as small urban vehicles, which can cope with a range of up to 100 km. Commercially available vehicles of this type are the THINK city from Think Global, MEGA City from NICE Car Company, G-Wiz from the REVA Electric Car Company and CLEANOVA from Dassault Systèmes.

On the other hand, there are increasing efforts to establish sports vehicles with high performance and good range, for example the Tesla Roadster. The vehicle, realised so far as a prototype, promises a range of up to 400 km per battery charge, in addition to good drivability.

While electric vehicles remain the exception rather than the rule in the passenger car segment, two-wheeled electric vehicles have already become established in the market. In the scooter segment in particular, electric vehicles can be widely found. Electric bicycles, scooters and motorcycles have proven to be successful in urban transport contexts, and in addition to this, there are already bans on traditional motorised two-wheelers in many cities. In China, particularly, the potential of electric two-wheelers is evident. In 2006 the same amount of electric two-wheelers as petrol two-wheelers were sold, and a broad supply industry has become established. In Europe too, the number of electric two-wheelers is rising, such as those from Vectrix or e-max.

FUEL CELL FOR RANGE EXTENSION

Fuel Cell Vehicles (FCVs) also represent a new generation of vehicles without a conventional ICE. Like battery electric vehicles, FCVs are propelled by electric motors. Whereas battery electric vehicles are limited in range by the energy stored in their batteries, FCVs „create“ their own electricity on-board. Fuel cells generate electricity through an electrochemical energy conversion process.

Such vehicles can be fuelled with hydrogen or hydrogen-rich fuels for a reasonable time. Therefore they are seen as a long term candidate for long distance mobility without the need of a charging infrastructure for batteries, but with the need of new and costly fuel infrastructure.

FCVs fuelled with pure hydrogen emit no pollutants; the products of the conversion process are only water and heat. FCVs are much more efficient than similarly sized conventional vehicles and allow, in combination with batteries, regenerative braking to increase efficiency.

For a successful market introduction significant research and development is necessary to reduce cost and improve performance as well as technologies for the cost and energy efficient production and storage of sustainable hydrogen.



AUTOMOBILE PLATFORM

EVs currently available on the market are mostly built based on an adaptation of a conventional automobile platform. This, however, does not allow EVs to develop their full potential. Due to greater simplicity and - for instance - fewer drivetrain components, electric concepts have the potential to significantly improve the economy of space and also offer more freedom when it comes to design in general.

Nowadays, OEMs commonly use shared automotive platforms; they are often even co-jointly developed and utilised. Platform strategies and modularity concepts are targeted at the possibility of broad usage and easy adaptation of variants. The goal is to minimise the amount of variant-specific parts among a vehicle family and consequently to achieve overall cost reduction, especially through lower purchasing costs. Of course, the initial efforts for developing such an automobile platform are tremendously high in terms of costs, manpower and time. Thus, platform developments can only be cost-effective when reaching if mass production is achieved.

These large investments that have been made for conventional automotive platforms and production facilities on the one hand and those investments that have to be made for new electric vehicle platforms on the other hand lead to hesitant changes in the automotive industry. However the decision to develop new approaches in design and development of electric vehicle offers high opportunities to establish new products and brands on the market and gain competitiveness for this high potential segment.

Another important aspect for future electric vehicle platform development is the formation of strategic alliances between the automotive and the electronics industry. Since the competence of the OEM industry has been focusing on mechanical components like ICEs and conventional drivetrains, electric traction and related technologies have not been a primary focus. The formation and establishment of strategic alliances can enable accelerated state-of-the-art development of electric traction systems and components in accordance with automotive standards.

In addition efforts have to be taken to simplify and coordinate technical regulations worldwide and develop new standards and harmonise homologation procedures. This is of high importance for a fast market introduction of relevant electric vehicle components, like switches, connectors, etc., as well as to support the establishment of vehicle platforms and by that mass production. Future increases of consumer-side demand for EVs as well as political incentives will contribute to steer these developments in the automotive industry.

CHARGING INFRASTRUCTURE

A precondition for successful market introduction of electric vehicles is the existence of an adequate charging infrastructure. The costs of developing a viable infrastructure, and if required the supply logistics, determine whether a new technology becomes established. A key advantage for the development of an electric charging infrastructure is the fact, that in developed countries practically every home has an electricity supply. If certain framework conditions are met, such as the wattage supply necessary to charge an electric vehicle within an acceptable period of time, a comprehensive infrastructure can be built up relatively easily and quickly. At the same time, the load on the electricity networks must also be taken into consideration. This shows that a variety of concepts must be pursued to develop an adequate charging infrastructure, but also that a dense network of charging stations can be implemented relatively cost-effectively.

Charging an EV is usually a matter of hours („overnight charging“) in order to guarantee proper lifetime and safe operation of the batteries. To overcome this issue where „charging along the way“ is not a solution, some vehicle manufacturers concentrate on the implementation of a fuel cell, which allows refilling within minutes and offers separate battery recharge as an option.



CHARGING INFRASTRUCTURE AND SUSTAINABLE ENERGY FOR ELECTRIC PROPULSION

CHARGING INFRASTRUCTURE FOR ELECTRIC MOBILITY

Mobility and buildings today constitute the main sector for fossil energy demand. The development of mega-cities and the growth in population destine zero-emission vehicles using renewable energy sources as prerequisite for sustainable mobility. Two main trends in development can be identified in moving towards these targets: one is based on regenerative hydrogen from biomass or renewable electricity in combination with fuel cells, and the other on renewable electricity generation as for example from photovoltaics, wind, biomass or hydropower in combination with new battery technologies. During a transition period, hydrogen generated by steam reforming of natural gas or electricity generated from fossil fuels or nuclear will also be used in regions of the world with limited renewable energy sources. Due to the major progress in battery technology, the electric plug-in car charged from the public grid seems on the way to experience a breakthrough in the near future.

Two types of electric vehicle can be distinguished:

- > The small electric car for rural and suburban short-distance transport. Here typical distances in the range of 10 to 50 km require an energy supply in the range of two to seven kWh. The car can be equipped with a low-capacity battery of about 10 kWh and the charging time is not critical. The battery can be charged either in the evening at home or during the day whilst parked. This sector represents the major mobility application, and appears to have the best chance of being realised in the near future. It has a low influence on the supply infrastructure, as is shown later.
- > The medium-size electric vehicle (EV), for long-distance mobility. Here the typical distances between recharging will be about 200 km. These cars must either be equipped with heavy batteries or in the future with new battery types with extremely low charging times of about 5 minutes. Compared to the traditional fuelled car, competitive disadvantages are likely to persist in the case of the EV for a longer time, in terms of technology and price.

Seen from the grid infrastructure perspective, short charging times of about 5 minutes for a driving distance of 200 km would require a charging power of about 300 kW per car. This would surely overload the traditional distribution grid, and would require electrical charging stations connected directly to the medium-high voltage grid. The high charging power would also require special measures to ensure technical and personal security.

Small EVs appear to have many advantages in terms of recharge from the supply grid, if they are charged over longer time periods. Charging times of several hours at night would be possible using the existing electrical grid. In micro-grids with decentralised renewable generation, the charging and discharging of cars could also be managed to provide balancing energy in response to periods of surplus generation or during peak load.

In general, the energy demand for small-scale electric mobility seems to be feasible using existing energy systems. If the energy demand could be reduced by about 25% through measures to achieve greater efficiency, the entire mobility demand could be switched to electric mobility without the need for new power stations and new grid infrastructures.



Electrical car: smart fortwo ev

SUSTAINABLE ENERGY FOR ELECTRIC MOBILITY

If the development of electric vehicles and charging logistics continues to be successful, a large scale introduction of electric powered vehicles into the transport sector seems possible, assuming an increase in availability of renewable electricity. For example, 100,000 electric vehicles (2.8% of all passenger cars in Austria in 2004) with a 200 Wh/km consumption and an average mileage of 15,000 km/year, need 300 GWh/year electrical energy, corresponding to 0.5% of the current electricity generation. So, a substantial number of vehicles powered by fossil fuels may be replaced through a moderate increase in renewable electricity generation.

To give a clear answer to questions related to the efficiency of the electric vehicle, it is necessary to extend the vantage point from vehicles to the entire system of energy supply in a comprehensive way. Besides the specific vehicle performance which mainly depends on differences in propulsion technologies, ways to produce electricity to power electric vehicles have to be considered. While focusing on the automobile gives electric vehicles a clear advantage, total performance strongly depends

on the circumstances in which the electricity is produced – besides efficiency, this aspect also influences the ecological performance like CO₂ emissions or airborne pollutants.

Basically, electric motors with a nominal power of more than 1 kW have efficiencies of around 90% while modern spark ignition engines achieve a maximum of 30%. Electric motors realise a more than 3 times higher efficiency, which is a major advantage for this technology. The comparison of different technologies for electric power generation reveals that performance differs widely (from about 35% to more than 90% taking cogeneration into account). The energy available for end-use, i.e. electric mobility, compared to the energy input by fossil fuels, ranges from about 30% to 80%, strongly depending on the technology of electric power generation. Concerning the 80% energy efficiency it has to be stressed that the non-electric use of heat is considered.

Besides the impacts concerning climate change, the level of pollutant emissions would also be reduced in the case electric vehicles were implemented widely. At present millions of vehicles equipped with their own exhaust gas treatment unit - operating in transient conditions - are produced in an effort to limit pollutants. In contrast to this, power plants have high standards for exhaust gas treatment in a comprehensive way – their centralised and stationary operation conditions could achieve better performance, regarding both ecological and economical aspects. Therefore fossil fuels burnt in power plants tend to emit fewer pollutants and, in addition, be more cost-efficient.

Today's technologies for renewable generation of electricity are at different stages of maturity, as can be seen in the following overview:

Hydropower

Fundamentally, this is a mature technology. There is still some potential for optimisation potential for small-scale hydropower plants. The current share of domestic electricity generation is 58%, and it seems possible to increase this to some extent, taking ecological requirements into account.

Wind power

Wind power plants have reached a high technological standard in the last decade. Wind potential is only exploited to around 30% of capacity in Austria. Under high wind conditions, it is necessary to apply temporary limitations on available grid capacity. The extension of pumped hydro storage capacities from the present level of 2,000 MW to about 5,000 MW in the next decade will solve the problems of balancing demand and storage to a large extent. The problem of grid capacities will still be predominant.

Photovoltaic power

This technology has been further developed in recent years, but it is not yet fully mature. There is insufficient knowledge with regard to lifetime and degradation. The potential for developing large collector fields is high if a significant reduction in investment cost can be achieved in the future.

Generation of electricity from biogas

The technology is mature, although consideration is being given to increase the electric efficiency (around 35% using gas engines) through additional downstream thermal conversion units (e.g. ORC).

Generation of electricity from solid biomass

Electricity generation from biomass combustion in the range above 5 MW is mainly based on the traditional steam turbine process. In the lower power range the ORC process will have a greater perspective for implementation. In the power range below 100 kW, implementation of the Stirling motor is being considered.

All these technologies are already deployed in combined heat and power plants with an electrical efficiency below 30%. In case of gasification of biomass, there is the possibility of increasing the efficiency of the combustion motors or gas turbines used by incorporating additional thermal converter technologies (see above). The additional cost of these measures makes economic operation unviable at present.



ENERGY STORAGE

The energy storage device can be seen as the key component of hybrid electric (HEV) and electric vehicles (EV). It provides power when needed and allows regenerative energy to be stored dynamically. It is obvious that the amount of energy available is crucial for the performance of the vehicle regarding its range. Another factor is the power the device can deliver, hence how fast the stored energy can be delivered. However, in vehicles, in contrast to stationary applications, the size and weight of the storage device is limited, therefore restricting the available power and energy. Beside cost, especially safety has to be taken into consideration in vehicle applications.

Various electrochemical energy storage systems have been introduced throughout the last decades for automotive applications like: Nickel/Cadmium (NiCd), Nickel/Metal Hydride (Ni-MH), Nickel/Zinc (NiZn), Lead Acid (LA), Valve-Regulated Lead Acid (VRLA) and Lithium-Ion (Li-ion) batteries. Beside these battery systems Ultracapacitors (UCAP) and a vast number of other devices such as fly wheel have been developed and tested. All of them have their specific advantages, and it is not possible to select a single system that suits all purposes, from pedal electric and Micro HEVs up to EV. Energy storage systems commonly considered to play a significant role in future transportation, are Ni-MH, Li-ion, VRLA and the UCAP. Since the characteristics and research issues of all these energy storages differ widely, this summary focuses especially on the most relevant batteries, Ni-MH and Li-ion.

Ni-MH and Li-ion batteries are among the latest developments in the area of rechargeable batteries. Their most significant difference to conventional systems is the use of what is known as insertion electrodes. In a conventional battery system the negative electrode is generally made of a metal such as Zn, Pb, etc. whereas the active components of Li-ion and MH batteries (Li and H respectively) – which can be handled only to a very limited extent due to their physical and chemical properties – are incorporated into a solid, electron conducting matrix. Lithium and hydrogen exhibit the major advantage of having a high specific charge, which on system level results in weight reduction.

NICKEL-METAL HYDRIDE BATTERY (NI-MH)

Nearly all HEVs commercially available today (Toyota Prius, Lexus LS600h, Honda Civic Hybrid) are equipped with this battery system. Operated in a rather narrow range (never fully charged, never deeply discharged), these batteries provide significant lifetime, power and safety. In general, Ni-MH batteries have moderate energy density and specific energy as well as moderate power density and specific power. The Ni-MH battery has many similarities to the NiCd battery; with the cadmium anode of the latter replaced by a hydrogen electrode in form of a metal hydride. A major advantage of this system is found in the replacement of a particularly problematic electrode material – cadmium. In the charged state, the positive pole of a Ni-MH battery consists of a nickel electrode which is covered with nickel oxyhydroxide. Its negative pole is a metal hydride (MH) alloy consisting of Ni, Co, Si, Mn, Al, Ti, Cr, V, Zr and rare earth metals (e.g. La, Nd). Between the electrodes a separator, soaked in alkaline electrolyte solution of K, Na and Li hydroxides, is situated.

During charging and discharging, significant volume-changes occur at the MH electrode due to the storage of atomic hydrogen in interstitial spaces. Such changes in volume result in massive mechanical stress on the rigid metallic structure. The mechanical stress is relieved by fracturing of the polycrystalline structure of the MH electrode. The mechanical stability of the intermetallic compound and therefore of the entire electrode structure determines the cycle lifetime of Ni-MH cells. Partial substitution of nickel with, for example, cobalt significantly improves the mechanical properties of these intermetallic compounds and thus the stability of the electrode matrix. Research has shown that the elasticity of the structure can be considerably increased by reducing the grain size. It was proved that nanocrystalline metal compounds, manufactured for the first time at the Vienna University of Technology (TU Wien) using a special cooling process, have lifetimes at least three times longer in a continuous charge and discharge cycling test, compared to conventional melted materials.



LITHIUM-ION BATTERY (LI-ION)

The Li-ion battery is the latest advance in battery technology and is already established and widespread in the field of portable devices. Many experts see it as a highly promising candidate in powering electric or HEVs within the next few years. Of all the rechargeable battery types currently available, Li-ion batteries exhibit the highest specific energy. As in Ni-MH batteries, the positive electrode of Li-ion batteries is also formed as an insertion electrode. Another special feature is the use of non-aqueous „aprotic“ electrolytes, since both metallic Li as well as Li-C intercalation compounds produce a violent reaction with water. The cathode matrix can comprise a number of materials, such as for example $\text{LiNi}_x\text{Mn}_y\text{Co}_z\text{O}_2$, LiMn_2O_4 , or Li_xFePO_4 . A porous polymer separates the cathode from the negative electrode, which is commonly made of graphite or in the newest configurations of Sn or Ti compounds. In both electrodes, lithium ions are absorbed and released reversibly.

During charging and discharging processes, the formation of protective layers at the phase boundaries between electrodes and electrolyte plays a key role. These protective layers are formed by the spontaneous reaction of the highly reactive lithium compounds with the electrolyte. Ideally, these protective layers – Solid Electrolyte Interphase (SEI) – possess high, (exclusively) ionic conductivity and force the lithium ions to completely lose the solvate envelope before being intercalated into the solid. In this way, they separate the electrodes from the electrolyte and prevent the intercalation of solvated ions, which, due to their large volume, would destroy the structure of the electrode. The considerably larger volume requirement due to the solvate envelope means that such processes lead to an „opening up“ of the layered structure of the graphite electrode and thus to rapid and irreversible damage of the electrode. The thermodynamic instability of the organic electrolyte components with regard to lithium or highly reactive lithium compounds also represents a problem for the gas-tight cell construction of Li-ion batteries. A gas-tight design is necessary to operate such cells with non-aqueous (aprotic) electrolytes, in

order to prevent the intake of humidity from the air and the immediate violent reaction of water with the charged lithium anode, resulting in the formation of hydrogen gas and lithium hydroxide. On the other hand, partial reaction of Li with propylene carbonate or ethylene carbonate – two components frequently used in electrolytes – can occasionally cause the evolution of gaseous propylene or ethylene and thus an undesired increase in pressure which, in certain circumstances, can lead to cell damage.

In fact, besides lifetime issues, safety concerns are still hampering the introduction of Li-ion batteries to the automotive market on a large scale. In contrast to Ni-MH batteries, prototype vehicles equipped with Li-ion technology often use batteries produced on small scale. Up-scaling, however, leads to significant quality problems which so far have not been completely overcome. In addition Li-ion batteries have a very high energy content which can cause hazardous conditions when released spontaneously.

To overcome this safety issue, the worldwide research community puts strong efforts in introducing more stable compounds, developing new cell and system design, and performing advanced abuse tests to assess the real safety level of a cell or an entire energy storage system. One key result of these activities is the steady improvement of the performances and safety of these electrochemical systems.

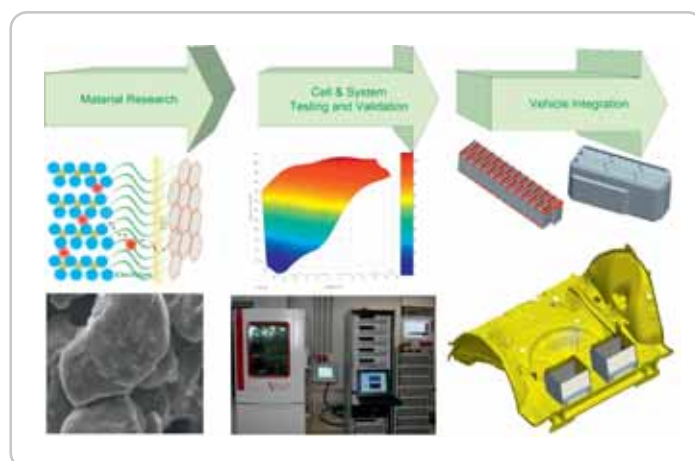

R&D process in developing electrochemical energy storage systems for automotive application

Li-ion chemistry offers the highest performance potential and high design flexibility. In this way a wide energy and power area of the Ragone Plot will be covered, thus fitting the requirements of a broad range of HEVs and EVs. On the other hand, there are still some major barriers/aspects preventing this technology from being introduced into automotive applications.

LIFETIME

The calendar life of energy storage devices is an important issue for any car application. Batteries developed for consumer applications have a target lifetime of three to four years, whereas in automotive applications it should be at least ten years. The high lithium voltage and the reactivity of lithium with the electrolyte, as well as the extreme environmental conditions to which the battery is exposed in a vehicle, raise major concerns over calendar life and cycle life. Material research is focused on seeking new compounds and these efforts have produced remarkable improvements, such as the latest developments on Li_xFePO_4 and $\text{LiNi}_x\text{Al}_y\text{Co}_z\text{O}_2$ cathode materials showing acceptable lifetime testing results.

TEMPERATURE

Another aspect of Li-ion batteries is the requirement to widen the operational temperature range. Cell conductivity decreases at low temperatures, this has a negative influence on discharge power performance, ruling out an acceptable regenerative braking strategy; it can even lead to hazardous lithium plating. The operation of Li-ion batteries at high temperatures is also an issue that is under continued investigation. An electrolyte operated at high voltages (typical of a high state of charge) and high temperatures can become unstable. Even without critical operating conditions, charging at high temperature and high rates can lead to gaseous electrolyte decomposition products, again raising safety concerns. For these reasons, research focuses on advanced electrolytes with improved conductivity at low temperature and stability within wider operating voltage windows, reducing the risk of potentially hazardous events occurring.

SAFETY

One of the most discussed aspects of Li-ion technology is its safety, which has proved to be the biggest barrier for implementation. Typical misuse conditions which could result in safety concerns are, for instance, overcharging and over-discharging, mechanical stress such as puncture and penetration, and exposure to high temperatures. Overcharge and over-discharge could occur even during normal operation of the energy storage system if the monitoring system does not operate properly, whereas penetration or exposure to high temperature is more often the consequence of an accident. Short-circuiting, too, could also occur either during normal operation as result of an internal short-circuit (within a cell), or as an external short-circuit following a puncture of the battery. All possible hazardous consequences of the events described above need to be investigated in detail and the possible issues addressed. Investigation is needed at two different levels: the cell level and the system level.

CELL LEVEL

At cell level research is underway to obtain more stable and safer materials. Examples of these are the new phosphate cathode materials or the new ceramic separators, which are more resistant at high temperatures and, in the event of a short-circuit, exhibit less shrinkage, meaning a reduction in the effects brought on by a short-circuit failure.

The reactivity of the lithium, as well as the likelihood of the organic electrolyte decomposition, could result in hazardous conditions (figure 2). Therefore research is focused on more electrochemically and thermally stable electrolytes and, at the same time, on more environmentally friendly and recyclable components.

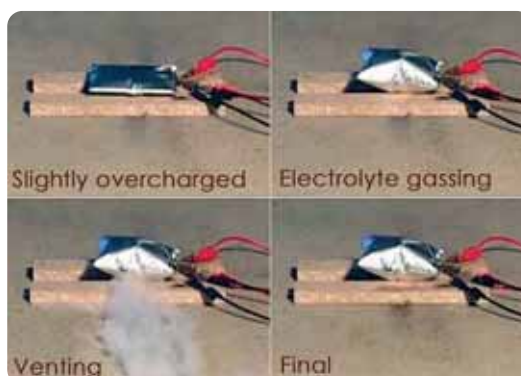

Figure 2: Overcharge test

SYSTEM LEVEL

At system level, research is focused on seeking new and safer materials. Moreover, at system level extensive investigation and efforts are required to ensure the safety of the energy storage system at all times and under all possible conditions. The occurrence of a short-circuit in on-board energy storage units is briefly described below, to illustrate the complexity of the system design task.

To achieve good efficiency and good power performance, the internal resistance of the cells should be as small as possible. As shown in figure 3, even at cell level the short-circuit currents could be of significant scale, and at system level – due to the large number of cells in series – these currents could be even higher. For this reason, each element of the system (electrical, mechanical, and thermal) needs to be designed and dimensioned adequately. For instance, the breakers and fuses in the energy storage system should be able to interrupt these high-voltage DC short-circuit currents. This task is only possible at the moment by using cumbersome and heavy devices which are not suitable for integration into a car.

Research at system level is therefore channelled to achieve the optimisation or improvements of the battery monitoring system to be able to predict the onset of a hazardous situation. At the same time, efforts are being made to develop new breaker technologies in order to reduce their size. Another important aspect to avoid short-circuit events is the mechanical design. Typical ICE vibrations or mechanical shocks generated by an accident should not affect the cell connectors, which are usually also the fixing points; if this is not the case, short-circuits are

likely to be the result. Therefore there is a need for specially-designed cell connectors and housings. With regard to the housing, its relevance for crash protection should be underlined. An external short-circuit represents already a serious situation, but it could cause additional hazardous conditions such as voltage reversal in other electrically connected cells. For these reasons, it is very important that the energy storage housing is suitably resistant, to prevent penetration which would otherwise result in external short-circuiting and, in some cases, in voltage reversal.

COST

Another key factor preventing the use of lithium-based technology is its cost. The cost of Li-ion batteries has decreased, mainly due to economies of scale, but further savings are still required. At the moment, this chemistry is competitive in terms of cost only on the consumer market and some niche markets. OEMs and independent research institutions have assessed the target costs for enabling Li-ion batteries to be introduced on the automotive market. The actual costs of Li-ion batteries are still higher than the target costs, both in $\text{€}/\text{kWh}$ for the energy cell and in $\text{€}/\text{kW}$ for the power cell, but the current oil price and the more restrictive regulations for vehicle exhaust emissions increasingly reduce the cost gap for Li-ion batteries, making HEVs and EVs more and more competitive. The production costs of lithium-based cells for HEVs are generally high, due to the high-purity materials required, the high development costs and expensive production equipment. Impurities within the electrodes or in the electrolyte lead to secondary reactions which strongly reduce performance and cell life.

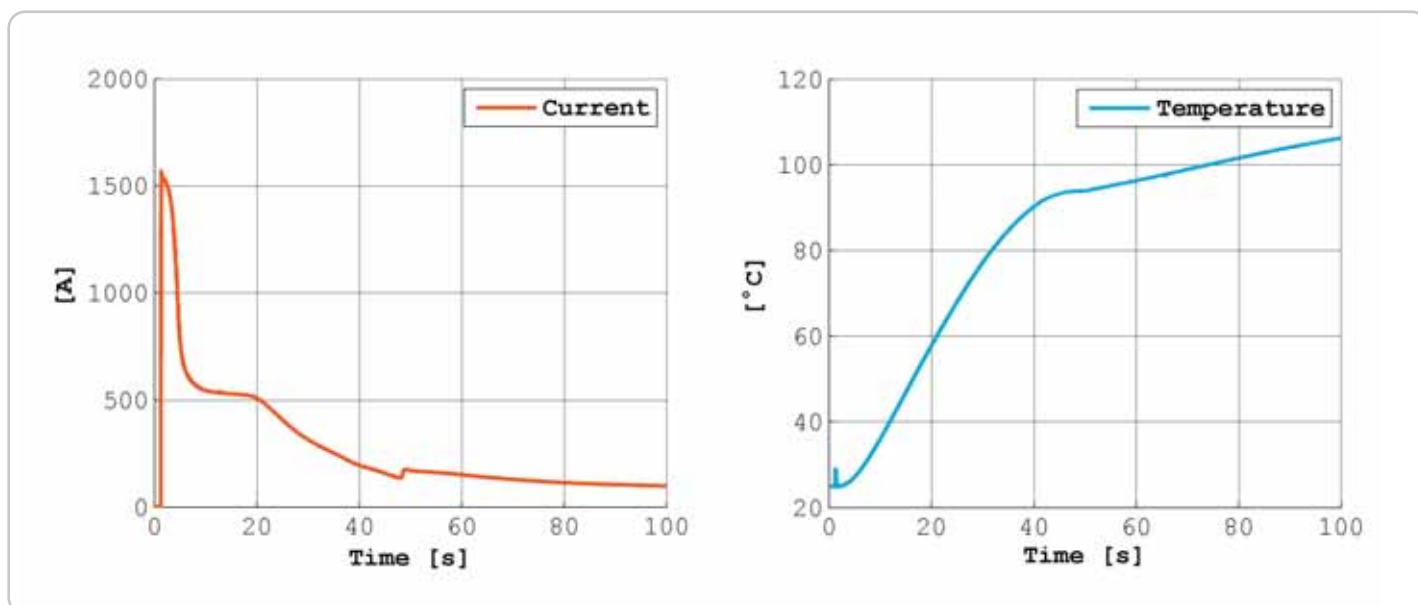

Figure 3: Short-circuit in a HEV cell

Regarding cell safety, the use of special components is required to avoid malfunction when incorrectly treated. For example ceramic separators offer better performance in such cases, but they are more expensive.

ADVANCED TESTING, AS A VITAL DESIGN METHOD

One of the key tasks of the development process for new energy storage systems lies in testing. Tests are used to verify material/cell/system performance compared to expected behaviour. For material investigations, typical electrochemical and analytical methods are adopted, such as cycle voltammetric testing, diffraction, spectroscopy, and many others.

As soon as the material is approved, test activities start on the cell level and are afterwards extended to the system level. Due to the many parameters involved (such as chemistry, size and the intended application), the variety of the tests increases. The standard tests, such as the capacity test and internal resistance test, which should be carried out at different temperatures, need to be supplemented with electrochemical impedance spectroscopy to correctly identify the dynamic behaviour of the cell. Efficiency tests are also required to assess the electrical and thermal efficiency of the cell/system. As soon as the main electrical performance values are identified and the cell/system fulfils the requirements, the environmental and misuse test takes place. Typical mechanical tests are vibration, drop and shock testing, nail penetration and crush tests. Thermal tests include the dewing test and testing for storage and/or operation at high and low temperatures, as well as at extremely high temperatures (e.g. to simulate proximity to fire). The electrical misuse tests to be carried out are overcharging and over-discharging, short-circuit and partial short-circuit and the voltage reversal test.

As mentioned earlier, calendar life and cycle life need to be verified, which means that an ageing test is required, even though it is expensive in terms of time and cost. To obtain a reliable assessment, additional measurements are often needed during the performance of some of these tests. In short-circuit tests, calorimetric measurements or thermal cameras are needed to identify the energy released during the event. To obtain reproducible and comparable results, all these tests require specific expertise and ad hoc-designed infrastructures (electrical test benches, climatic chambers, vibration test benches, a misuse facility). Often these tests need to be performed at cell level and repeated at system level (within the module or package). Different aspects are taken into account during this repeated testing: at cell level the investigation usually

assesses the cell's suitability for the envisaged application, whereas at system level the focus is on the system components such as the Battery Management and Monitoring System (BMS), breakers, thermal management, communications etc.

STANDARDISATION

The performance of Li-ion batteries is different from that of Lead Acid batteries and consequently also the test methods. Li-ion batteries are a relatively new technology and therefore suitable automotive standards are often to be developed. Nevertheless, the task of testing this technology is time-consuming and expensive, and to make this development as effective as possible harmonised standards need to be specified. For this reason, research institutes worldwide, government entities, OEMs and TIERS are working together in a task force focusing specifically on standardisation.

HARDWARE IN THE LOOP TESTING (HIL)

Adopting advanced testing is one way to accelerate the development of energy storage, thereby reducing its cost. 'Advanced testing' refers to such methods as 'hardware in the loop' test benches, where a virtual application linked to a real battery runs specifically designed tests under reproducible conditions. As examples, the process of designing the BMS or the vehicle energy management verification can be simplified and carried out in shorter times using this kind of equipment. Figure 4 shows the configuration of the arsenal research HIL test bench. Figure 5 shows the AVL Battery Testing Solution based on the RT (realtime) HIL System with Cruise RT Models. That approach is part of the TÜV certified Safety Concept for testing Li-ion batteries.

SYSTEM INTEGRATION

Fitting a battery into a vehicle raises up the following issues: weight, volume, heat and vibration as well as safe installation, operation and maintenance (high DC voltages). In order to obtain the required performance and at the same time a long lifetime and low costs a proper system selection depending on the given application and an optimization within the context of the entire powertrain is necessary. The use of advanced battery simulation tools and testing equipment supports the complex selection and optimization task.

While in Mild HEVs the cost per kW and weight is not a relevant issue and therefore, for example, rather heavy VRLA batteries can be (and are) used, cost per kW and weight are of big concern in Full HEVs or even EVs. Scooters also need low-weight and low-volume batteries, but in this case the cost per kW can be higher than in EVs, where hundreds of cells are integrated.

As batteries produce waste heat during charging and discharging, a sophisticated cooling system must be implemented. Depending on the battery type and size, this is either simple air cooling or liquid cooling with a connection to the air conditioning system of the vehicle. System integrators and automotive component suppliers like Magna Steyr Fahrzeugtechnik and AVL List GmbH are two Austrian companies making strong efforts into this field.

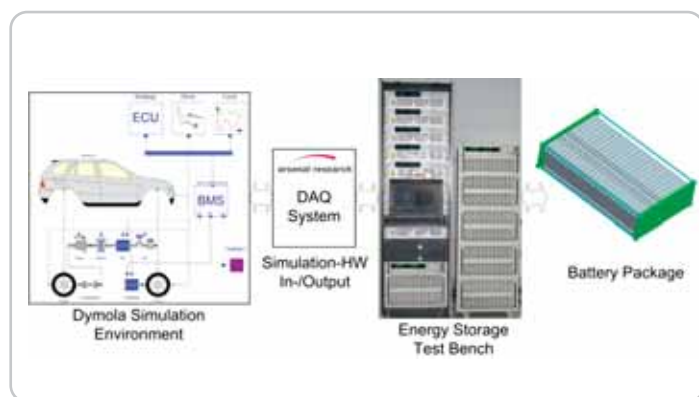

Figure 4: Advanced test method: HIL test bench

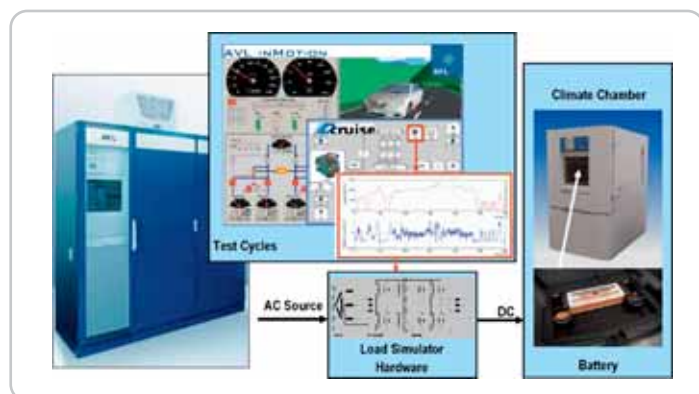

Figure 5: Battery Testbed with RT HIL Simulation and Safety Concept

BATTERY MARKET AND SITUATION IN AUSTRIA

Automotive manufacturers as well as their component suppliers seek close cooperation with battery manufacturers. Recent examples are Toyota/Panasonic, Audi/Sanyo and Bosch/Samsung.

The cells used in their systems however cannot be purchased off-the-shelf.

Battery manufacturers are situated in the Far East (e.g. China, Japan and Malaysia) and in USA (e.g. A123 and JCSaft). European manufacturers limit their activities to R&D and small-scale production in Europe and have set up production plants in Asian Countries. An example of companies directly related to battery production in Austria are Varta and Banner, and machines for battery components are sold by e.g. Battery Machines GmbH and HADI Maschinenbau GmbH. Battery research is carried out by several universities and companies in Austria, very often within international cooperation. For instance, the Vienna University of Technology (TU Wien) and the Graz University of Technology (TU Graz) are involved in material research, whereas institutions like arsenal research are involved in the design and the performance/safety assessment of the new generation of energy storage systems.

CONCLUSION

In summary, further R&D is necessary in order to fulfil the requirements in terms of lifetime, an extended temperature range, a reduction in cost as well as safe and sustainable chemistries and cell design. R&D has already brought improvements in most of these areas, while some aspects still represent an obstacle to large-scale introduction of lithium technology. Despite this, from today's perspective it seems very likely that lithium technology (most likely in the form of lithium ion technology) will be the mid- and long-term pathway for HEVs and EVs.

ELECTRIC DRIVES

For various reasons, the number of electric motors in vehicles is steadily increasing. On the one hand, there is a need to satisfy customer demand for different comfort features, such as electric window winders, electrically-adjustable side mirrors, or automatic air conditioning with electric flap vent systems. On the other hand, electric drives offer a wide range of possibilities for increasing the energy efficiency of the vehicles' powertrain. To decrease the load on the internal combustion engine, conventional auxiliary units (such as the water pump, oil pump or steering booster pump) are electrified. Electrification allows demand-responsive and thus energy-efficient operation of these auxiliary units, instead of continuous operation due to a fixed linking of the auxiliary unit to the combustion engine.

In addition to optimising the auxiliary units, electric drives play a key role in implementing new powertrain concepts. The low efficiency of combustion engines, especially under partial load conditions (e.g. stop and go operation in urban areas), can be compensated by combining an ICE with an electric machine.

The downside is that integrating a large number of electric motors (for reasons of comfort, safety and efficiency) leads to a significant and undesired weight increase of the vehicle. In addition the load on the on-board electrical network, especially the battery system, increases significantly. The availability of highly optimised electrical systems is therefore one of the key issues for tapping the full potential of electric motors in vehicle applications. One key issue in designing and selecting appropriate electric components is to consider the vehicle as a complete system. Considering and developing different components individually, without taking into account the wider vehicle system, may lead to optimisation at the component level that usually does not result in an optimised overall system. Optimisation in relation to cost, power and energy efficiency can only be achieved on the basis of detailed investigations of the requirements at system level as well as for subsystems and components.

Since mechanical and electrical systems have to be optimised and integrated for advanced vehicle concepts, changes in the development process are required when compared to the development of conventional vehicles and powertrains.

Appropriate simulation, design and testing tools have to be applied, permitting full consideration of these multidisciplinary and complex systems and supporting the entire development and optimisation process, whilst reducing time and cost expenditure.

To realise highly optimised electric drives, all the drive components – the electric machine and the power electronics, including control and the energy storage system – have to be taken into consideration (figure 1). Since energy storage has already been discussed in the corresponding section, this section is focusing on electric machine, power electronics, control systems and their interaction.

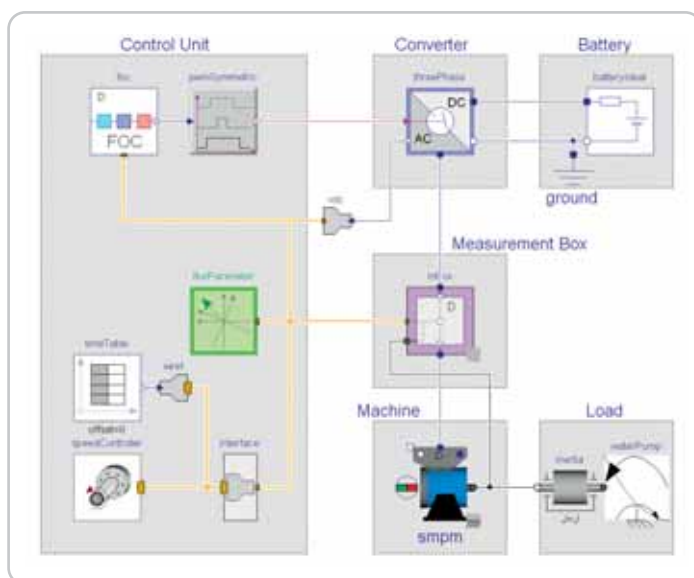

Figure 1: Electric drive model, indicating the main e-drive components and their interdependencies

ELECTRIC MACHINES

The speed and torque of electric machines can be regulated very flexibly. Independent of the machine type, the speed and torque of the machine can be adjusted to the requirements of the drive using modern power electronics. Mechanical transmissions or clutches are not essential. Depending on the power requirement and the available space, brush DC motors or induction motors can be used. The electrical drives for comfort systems are mainly realised using brush DC drives, whereas induction motors can also be used for electric auxiliary units, depending on the power requirement. However, with regard to electric auxiliary units, special emphasis on the development of compact, highly integrated and low-cost components is needed. The main advantages of electric drives for traction, compared to conventional propulsion systems, are their higher efficiency, robustness and better controllability. The efficiency of electrical traction is about 90%, depending on the performance class.

The efficiency of propulsion systems using ICE is about 30%, due to thermodynamic restrictions. A further advantage is that electric drive systems require far less maintenance.

Due to their robust assembly, their power density and their high dynamics, three-phase induction motors are preferable to direct current machines. Permanent magnet synchronous motors (PMSM) offer particular advantages due to their high power density. However, the choice between an asynchronous induction motor (AIM) or a PMSM depends largely on the requirements and the design of the vehicle. The selection process to identify the most appropriate machine type needs to be based on a comprehensive vehicle simulation which takes into account the given vehicle application (defined by the driving cycle, range, acceleration, etc.), as well as the entire powertrain concept and the interdependencies with other vehicle components, such as the battery system or the combustion engine.

	AIM	PMSM
Advantage	<ul style="list-style-type: none"> + Simple and robust assembly + Machine is passive, with no voltage or torque under currentless conditions + Good short-term overload behaviour + No danger of demagnetisation during overload operation + Easy implementation of field weakening to expand the speed range + Slightly lower costs 	<ul style="list-style-type: none"> + High power density + Lower weight + Short-term overload capacity + No power loss to excitation field production + better power factor below field-weakening
Drawback	<ul style="list-style-type: none"> - Lower power density - Higher weight - Additional current required to magnetise the rotor - lower power factor due to magnetization current 	<ul style="list-style-type: none"> - Complex rotor assembly through use of various materials such as metals, magnets, adhesives - Temperature sensitivity of the rotor - In case of rotating the machine mechanically the permanent magnets cause induced voltages even if the machine is not connected electrically - Active field weakening due to additional current required to expand the speed range - Slightly higher costs

Table 1: Comparison between the main advantages and drawbacks of asynchronous induction machines (AIM) and permanent magnet synchronous machines (PMSM)



Cross section of an AIM



Cross section of a PMSM

A comparison of the key characteristics of AIM and PMSM, together with their main advantages and drawbacks, is given in table 1. It can clearly be seen that the key advantage of the PMSM is its high power density and, as a consequence, lower weight to compensate for different drawbacks like complex assembly or control. By using the latest permanent magnet materials and by taking account of these materials in the motor design process, further optimisation can be achieved in terms of the power density of the PMSM.

By comparison, the power of the AIM can be increased for example by using copper rotors with copper bars and soldered rotor end rings. Compared to traditional cast aluminium rotors, this offers advantages in terms of the electrical behaviour of the machine due to reduced losses and higher efficiency.

In the system analysis, different aspects need to be taken into consideration to select the most appropriate machine type, such as:

- > Power requirement (continuous output, peak power, speed, torque)
- > Weight or power density
- > Available space (highly integrated solution)
- > Cost
- > Environmental conditions (cooling, weather-proof, dirt)
- > Availability and cost of materials
- > Manufacturing (standardisation versus special-purpose solutions)
- > Reliability, especially in relation to robustness and monitoring
- > Suitability for series application

This wide-ranging of conditions requires a comprehensive development for the electric machine. The design process, looking at electrical and thermal behaviour, the choice of an appropriate cooling system, and the packaging of the entire electric drive, is essential to realise a highly integrated and optimised electric machine for automotive applications.

POWER ELECTRONICS

The power electronics connect the electric machine to the energy storage system. Since the electrical energy storage provides direct current or direct voltage, the power electronics have to convert this into alternating current or alternating voltage according to the requirements of the electric machine. This allows the power electronics to influence the speed and torque of the electric machine, therefore playing an essential role in optimising the electric drive.

To convert direct current into alternating current, the semiconductors on the power electronics perform a large number of switching processes, consequently resulting in additional losses. Reducing these losses (switching and on-state losses) is one of the key issues in developing high-efficiency solutions. Research and development is required to integrate the latest low-loss semiconductors. In addition, optimised and innovative control procedures for power electronics and the electric motor offer the potential to further improve efficiency.



CONTROL

In the first instance, the control of the electric drive adjusts the speed and torque of the electric motor. The control system has to be chosen and developed with regard to the design of the drive, the machine type and corresponding power electronics. Usually this control system uses cascade structures to perform different tasks, like current control or speed control. The performance of modern digital signal processors and their intelligent programming allows them to be employed as a multitasking operating system to implement sophisticated control structures.

Besides time-critical tasks (such as controlling the semiconductor valves for the power electronics), the control parameters of the electric drive can be monitored and adapted continuously. In this way the influences of temperature or different loads on the drivetrain can be compensated. By adapting the control parameters, the entire drive can be operated at a predefined optimum.

Additional tasks which the signal processor can perform using appropriate algorithms include: diagnosing the status of the electric machine, sensorless control of the machine, and handling communications between the electric drive and the vehicle's energy management system. The basis for programming the signal processor is the mathematical modelling of the drivetrain components. Appropriate simulation tools support this development and optimisation process, reducing the expenditure required to implement the mathematical models as executable codes. Sophisticated modelling of the drivetrain components is therefore required to realise real-time enabled models with an appropriate level of detail.

Besides considering and optimising these electric drive components, attention also needs to be given to how the entire electric drive (comprising the electrical energy storage, the power electronics, and the electric motor) is interconnected. The cabling of the components has to be kept as short as possible to prevent additional losses. Development efforts therefore need to focus on strong integration of the electric machine and the power electronics.

In addition, high-voltage concepts are needed to provide the power for electric propulsion without high losses and weight. Using high voltage consequently raises safety issues and requires appropriate safety concepts, supported by highly integrated electric drivetrain components.

Summarizing the key issues of electric drive development for automotive applications, includes consideration of the electric components within the context of the given vehicle concept, the optimisation of the components within with the given system and the use of the latest materials, technologies and development tools.



INTERNAL COMBUSTION ENGINES AND TRANSMISSIONS FOR HYBRID POWERTRAIN SYSTEMS

Peak efficiency of internal combustion engines (ICE) in the range of 40-42% cannot be transferred directly to the total powertrain efficiency of road vehicles, due to predominant part load operation – particularly in the case of passenger cars. The best efficiency in real driving cycles is in the range of 23-25%, using DI-Diesel engine based powertrains (without hybridisation). Hence the main objective for the application of hybrid technology is to shift the engine operating points into these high-efficiency areas and to apply advanced combustion systems leading to extremely reduced emissions. In addition energy can be recovered which would be wasted during braking without hybrid technology. Hybridisation of the powertrain offers possibilities to improve total propulsion efficiency by more than 30%. Also, the comfort and drivability of the car can be improved with a hybrid powertrain (e.g. with torque assist during gear-shifting or boosting with the electric motor respectively).

Another important aspect for the ICE in a hybrid powertrain is that boosting can be used not only to improve vehicle performance but also to reduce emissions during transient operation. If the highest loads occurring during acceleration phases are eased by electric machines used in HEVs, NO_x emissions – along with particulates – can be reduced by up to 25% (figure 1). This is also accompanied by a reduction in fuel consumption respectively in CO_2 emission.

Therefore, the application of hybrid technology requires quite specific ICEs and transmission concepts. The ICE can be further optimised in terms of fuel consumption and emissions due to a smaller relevant range of operation. On the other hand, the transmission has to provide extended torque and speed conversion capabilities.

In particular, the ICE for a hybrid powertrain can be designed in such way that it operates with highest efficiency at average road loads. The engine size can be reduced (downsizing) since additional power and torque can also be provided by the electric motor. However, in order to maintain peak performance and driveability, the engine has to be capable of providing higher specific power output. Higher power densities, i.e. 25 bar brake mean effective pressure (BMEP) and above, require engines with new turbocharger technologies such as variable turbine geometries, even for gasoline engines. Furthermore, the compressors will also have to feature variable elements in order to cover the full mass flow requirements of such engines. Last but not least, 2-stage turbo-charging with inter-cooling (which is quite common for high-power medium-speed engines) needs to be applied for Diesel engines and will certainly be an attractive option also for future gasoline engines. Of course, sophisticated control strategies need to be developed to enable a smooth build-up of boost pressure across the entire engine map and, in particular, during transient engine operation.

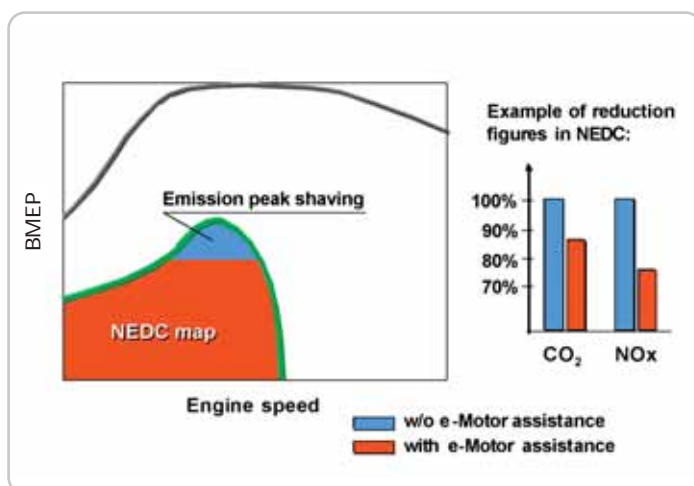

Figure 1: Emission reduction through e-motor assistance in the New European Driving Cycle (NEDC)

Hybrid powertrains also enable extended electrification of the auxiliary drives of the ICE. The main advantage of this step is in operating these devices „on demand“. Water and oil pumps, hydraulic servos, and even vehicle-side functions powered by the ICE today can be powered electrically and thus activated only if needed.

The benefits listed above can only be exploited if a highly flexible transmission is available. These special transmissions for hybrids will need to feature extended torque and speed conversion capabilities and will need to be controlled fully automatically. The following architectures are suitable for different degrees of hybridisation:

- > Automated single clutch, 5-6 gear step
- > Automated dual clutch, >6 gear step
- > Continuously variable transmissions (CVT)
- > Infinite variable transmissions (iVT with mechanical torque split)
- > Combined mechanical-electrical torque split transmissions (such as Toyota Prius)
- > Automatic transmissions with multiple planetary gear steps and integrated electric motors
- > Electric transmissions (integration of e-motor and generator)
- > Series hybrid arrangement with separate ICE-generator unit and fully electric drivetrain

Further improvements can be achieved with low loss gear geometries, low friction oils, lightweight materials, better integration of electric motors and electric motors, and inverters with high efficiencies in wide operating ranges.

With a view to long-term research, there is potential for further improvement for combustion engines. In fact, the net efficiency of the ICE is lower than the theoretical efficiency mainly because of losses through wall heat and the exhaust. The best large slow-speed engines today (80-90 rpm, (>1000 L/Cyl)) achieve efficiencies of around 50%. The major difference between small passenger car engines and these very efficient large engines are the higher wall heat losses, leading to lower peak efficiencies of approx. 42% in smaller ICEs. Hence research breakthroughs are needed to achieve these higher efficiencies, which would also help to improve the efficiency of the overall hybrid powertrain.

Finally, the exhaust heat losses of ICEs similarly offer further improvement potential, if they can be partly recovered using turbo-compound devices, Rankine bottoming cycles and thermoelectric generators. These latter devices are working today with efficiencies of around 5%. New materials are under development which will lead to conversion efficiencies of 10%. Long-term research has to focus on the development of materials with peak efficiencies >20%, which is basically possible from a theoretical point of view.



The hybridisation of both Diesel and gasoline engine-based powertrains provides for improvements in fuel consumption. The higher part load losses of port injection gasoline engines offer greater improvement potential by shifting the operating points due to downsizing. For example, if the swept volume of a 4-cylinder engine in mild hybrid powertrain is reduced from 2.0 L to 1.6 L and the specific torque is increased using advanced turbo-charging, approx. 30 % fuel consumption can be saved with 50% add-on costs. Most important, the driveability of such a hybrid powertrain is much better because of the high and smooth torque characteristics of the e-motor.

An example of a Diesel engine-based hybrid powertrain with very low CO₂ emissions is realised in the joint research project „ECO TARGET“ (by AVL, GETRAG and ATB Thien). This system combines a highly efficient 3-cylinder DI-Diesel engine with 1.2 litre displacement with an automated 6-speed transmission. In this transmission, an electric motor is integrated in such a way that torque can be supplied to either the input or output shaft of this transmission. Hence, the motor can work also as a generator during electric braking or as the starter for the ICE. Electric energy is stored in supercapacitors which are directly mounted on the e-motor – DC/DC-converter unit. Hence the arrangement results in a very compact design, very low ohmic losses and no problems in terms of electro-magnetic-compatibility (EMC).

The system is installed in a mid-class vehicle with approx. 1350 kg test weight. Current average CO₂ emissions for this vehicle class are in the range of 160 g/km. The benchmark for the hybrid system is a similar car with a 2.0 litre DI-Diesel engine with 132 g/km of CO₂ emissions.

With the steps for downsizing and hybridisation, CO₂ emissions of less than 100 g/km can be achieved at the EURO 4 emission level. If alternative combustion and thermal encapsulation of the powertrain are taken into account, CO₂ emissions close to 90 g/km at regulated emissions far below EURO 4 are feasible.

In conclusion, and summarising the considerations relating to hybrid powertrains with internal combustion engines, it can be stated that further improvements – in the range of more than 25% – are still possible. Of course, this cannot be achieved through continuous development of the technology alone, but will also require long-term research to realise the breakthroughs required.



VEHICLE ENGINEERING FOR HYBRID AND ELECTRIC VEHICLE POWERTRAIN SYSTEMS

Not only the vehicle's powertrain will undergo significant changes but also the vehicle itself will be reengineered addressing the new requirements of an increasingly bigger electrical storage system and new auxiliaries.

Converting existing vehicle platforms is a feasible way for „add-on“ hybridisation but is not smart when designing new plug-in hybrid electric (PHEVs) or new electric vehicle (EV) concepts. New design concepts are required to fulfil all demands for functionality, safety (crash), cooling systems and high voltage auxiliary systems.

A difficult point in the process of converting a conventional vehicle into a hybrid vehicle is to integrate a reasonable big battery pack and maintain inner space as well as the centre of gravity required for good driveability. The crash behaviour has to be considered in an early stage, simulation and testing has to ensure the position and packaging. Further auxiliary systems such as electric steering, electric braking aid and the new cooling systems for electric motors, inverters and especially the battery need to be implemented. Today many of those systems are not available in the high voltage range and have to be taken off the low efficient 12V shelf. Usually, vehicle-specific solutions are the outcome, which are an additional obstacle for the desired standardisation of products such as battery packs.

New vehicle platforms need to be designed to provide purpose built solutions for PHEVs and EVs. This case can ease the target conflicts a bit, as the vehicle can be literally „built around the battery pack“. Design studies have shown that the optimal position of the battery is a „T“, using the tunnel and the place under the rear seats. This location gives best load distribution and security in case of a crash.

Furthermore, the high weight of the battery pack in an electric vehicle needs to be compensated by new space frame concepts and the use of lightweight materials.



CONCLUSION

The transport industry will face demanding challenges in the next few years and will be forced to reduce emissions of greenhouse gases (GHG), pollutants and noise as well as increase energy efficiency, the use of renewable energy sources, vehicle safety and the life-cycle sustainability of the vehicle from cradle to grave by use of renewable materials and recycling. All this has to be achieved by keeping consumer comfort at the same level as well as keeping investment and operating costs low.

A significant reduction of GHG emissions in the transport sector can only be achieved by a significant increase of propulsion system efficiency. From a variety of technical options especially hybrid electric vehicles (HEVs) and electric vehicles (EVs) have become promising candidates for a sustainable transport system. The assets of the electric drivetrain are the high efficiency of the electric engine, its robustness and limited maintenance requirements as well as flexibility in controlling torque and speed. The big advantage of EVs for the urban environment is that they can run without any pollutant emissions, with only negligible engine noise at the point of operation and that they even eliminate GHG emissions by using electricity produced from renewable energy sources.

In the last few decades many mechanical auxiliary components of vehicles have been replaced by electric and electronic components. Recent impressive improvements of energy storage and power control systems opened up new opportunities for also introducing electricity in the propulsion system and complementing or replacing the internal combustion engine (ICE) by an electric machine. Unlike the technical shortcomings of EVs in the 1970s and 1980s these technical breakthroughs have paved the way to economic success for the HEVs.

With the success of Japanese HEVs, hybrid technology has been established on the market for more than 10 years. This has brought about not only economies in fuel consumption but also in pollutants and noise, especially with uses in urban traffic. Today many OEMs offer HEVs and all companies are investigating a further increase of the electrical energy share in the propulsion system. HEVs with an extended electric drive range are of special interest. HEVs recharged through the electrical grid, plug-in hybrid electric vehicles (PHEVs), symbolise a big step towards pure electric driving. The deployment of this technology is mainly possible due to significant improvements of energy storage systems within the last years. Among a long list of possible candidates especially Li-ion batteries are seen as the most promising candidate for future HEVs and EVs. Improvements concerning energy and power density, life time and safety have been realised due to intensive research. Nevertheless further R&D will be necessary in order to further reduce weight and costs through R&D in materials research as well as for simulation and testing methods for subsystems and the entire drivetrain. The second enabling technology for the

HEV is the electronic control system which allows efficient interaction of different energy converters and storage devices. Their mass-production and integration into optimised complete propulsion systems will allow hybrid solutions with two or even more components like ICE, battery, super-cap, or fuel cell.

The expected cost reduction of the energy storage system through mass production might not be enough to make the technology competitive. Alongside with a growing market penetration of electric vehicles and a growing infrastructure, there will be a demand for new business models for EVs and battery systems. This seems obvious especially in connection with the possible scenario of exchangeable battery system applications for range extension. For instance, a special lease plan quite similar to a mobile phone contract will be realised in the Better Place project. Frost & Sullivan expects a worldwide share of 75 percent of leased battery systems among all electric vehicle registrations in 2015. An aspect that favours lease plans from the perspective of OEMs might also be the uncertainties regarding life time performance and uncertainties regarding battery systems in general due to the lack of real world operating experience. This concept further enables charging procedures at filling stations, addressing consumer requests in terms of facilitating a fast and simple procedure, which involves the replacing of empty batteries by charged ones within a few seconds.

In order to avoid the potential risk for the customer of changing a good battery for a bad one and to reduce the relatively high capital costs for batteries not used in the vehicle during their charging cycle, the automotive industry is developing fast charging technologies. The challenges of this approach are infrastructural investments in rapid charging installations, reduced energy efficiency in the charging cycle, problems related to safety issues for customers as well as thermic overuse of battery systems. Another option, subsumed under the phrase „charging along the way“, provides charging infrastructure at restaurants, shopping malls, public off-street parking, at home etc., comparable with installations used for pre-heating in Scandinavia.

The charging of EVs brings up the issue of energy sources needed for electricity generation. Although local improvements of air quality and noise reduction in urban environments can be achieved even with electricity from fossil fuels it is clear that a real step towards a sustainable mobility system has to rely on renewable energy sources. While currently completely dependent on fossil fuels, the road transport could open up possibilities for renewable resources like hydro-, wind or photovoltaic power generation. Electricity generated during low consumption periods could be stored in batteries of electric vehicles (grid to vehicle). This energy or additional electricity from on-board fuel cells could be fed into the grid to cover demands of peak current (vehicle to grid), replacing storage power plants with bad efficiency.

The substitution of fossil fuels by biofuels in the ICE of the HEV or in power plants might offer additional benefits in terms of GHG emissions and energy security. The European Union has therefore set mandatory targets for biofuel substitution for 2010 and beyond. Concerns about rising food prices and endangering biodiversity by converting land to biofuel production, as well as uncertainties over CO₂ reduction values, have led to calls for the reduction or outright rejection of these targets. Regarding the latest announcements of the European Parliament and the European Commission and proposals concerning the promotion of renewable energy in the European Union, electric mobility seems to play an increasingly important part in future scenarios as discussions on derating targets for biofuels are under way, favouring cars running on green electricity and hydrogen. Another remarkable issue concerns the scope of the renewable directive, now widening up from road to all modes of transport incorporating train, air and maritime where fossil fuels are utilised. This latest political development further tends to stimulate market penetration of hybrid and electric vehicles and, furthermore, opens new markets for R&D projects involving modes of transport other than road.

The limited range of EVs is generally seen as the main drawback for their market introduction. Although statistical evidence shows clearly that already existing battery technologies cover the overwhelming majority of daily trips, the psychological reluctance of vehicle users to use an EV for fear of getting stuck on the road if they need to travel further has to be taken seriously. Most OEMs therefore foresee a split of the vehicle market into segments optimised to specific applications. HEVs using ICE or fuel cells offer clear advantages in range. But the extraordinary expense for the need of several cars is a major economic barrier for their market introduction. At this point transport policy comes into play facing the problem that citizens are under economic pressure to use the car as often as possible as soon as they acquire a vehicle. The high investment costs of buying a vehicle and its quick devaluation within a couple of years make it hardly attractive to switch between different transport modes and choose better or more sustainable transport means. Models separating the use of a vehicle from ownership like car-sharing and car-pooling or leasing models for the whole car similar to those for the battery as described above might be a solution for using the optimal vehicle or transport mode for each trip.

For the eco-balance it is necessary to consider the end of lifetime of the battery systems as well. Recycling processes for current battery systems either depend on metal recovery for economic feasibility (e.g. nickel, cobalt) and/or on regulatory framework conditions reducing the environmental impact (e.g. lead). Future automotive batteries are likely to use little or no nickel/cobalt and very small amounts of precious metals if any at all. Purity requirements for materials used in batteries are generally very high. Therefore, new and improved recycling processes need to be developed for new cell chemistries in

order to recover as many materials as economically possible. As recycling generally has lower environmental impacts than primary production it should be taken into account in the development of new cell chemistries and for the design of the next-generation battery systems. Future battery chemistry with higher energy and power density, extended lifetime and reasonable costs needs to offer possibilities for recycling at adequate costs.

Summing up the state of vehicle technology one can say that hybrid technology is available on the mass market today. Generally technology for electric vehicles fulfilling the needs of daily transport within a range of up to 50 km is available in principle but not on the mass market. Besides the requirements regarding energy and power density, the price of the energy storage systems, as well as safety issues and efficient power electronics seem the main hurdles to be overcome for a successful pure battery electric vehicle on the mass market.

As mentioned before, power electronics play a key role in the future of hybrid and electric vehicles. The automotive power electronics market has been growing significantly over the last years, even at a higher rate than the vehicle market. The main area of application for microelectronics is the drive train. Recent studies showed that a shift of the OEM's value chain from the drive train to power electronics is already visible. The turnover of electronic parts in the automotive sector is roughly estimated at 10 billion US\$ for Europe alone in 2009. At present, suppliers are strongly investigating cost effective, compact, durable safe and highly integrated systems. Unlike other areas of application, power electronics for hybrid and electric vehicles require a close interlinking of the subsystems (control and power electronics, electric drive and the ICE). The challenge is to develop a compact system with an efficient thermal management, high reliability and lifetime at moderate cost. Therefore a close cooperation of all stakeholders on the standardization of components will be necessary in order to bring costs down. The introduction of hybrid systems offers new chances for the automotive supply industry. The value chain of future vehicles will be different to conventional ICE vehicles as the energy storage system and power electronics have a valuable share of costs. This circumstance may also offer a chance for smaller automotive suppliers. The progress of R&D and the strong interest of car manufacturers in the electric drivetrain give a positive perspective on the future of electric drivetrains used for HEVs and EVs.

Austria has many competent industrial companies and research institutions working in the field of hybrid and electric vehicles, energy storage technologies and electronic control systems. The BMVIT has been funding their R&D activities through research promotion programmes and centres of competence for many years. The following chapters describe the high expertise of these industrial and research partners in the product Know How and engineering of the electric drivetrain.

- > ENVIRONMENTALLY FRIENDLY URBAN BUS AND GOODS TRAFFIC SYSTEMS
- > INK
- > PEM FUEL CELL HYBRID VEHICLE
- > QUANT-B
- > BIO-SOFC DRIVE
- > PEMFC – SMALL TRACTION
- > ALTANKRA
- > ELYSE
- > FUEL CELL APPLICATION IN INTRALOGISTICS / HYLOG
- > HYPERBIKE
- > IEA COOPERATION
- > ZEMC

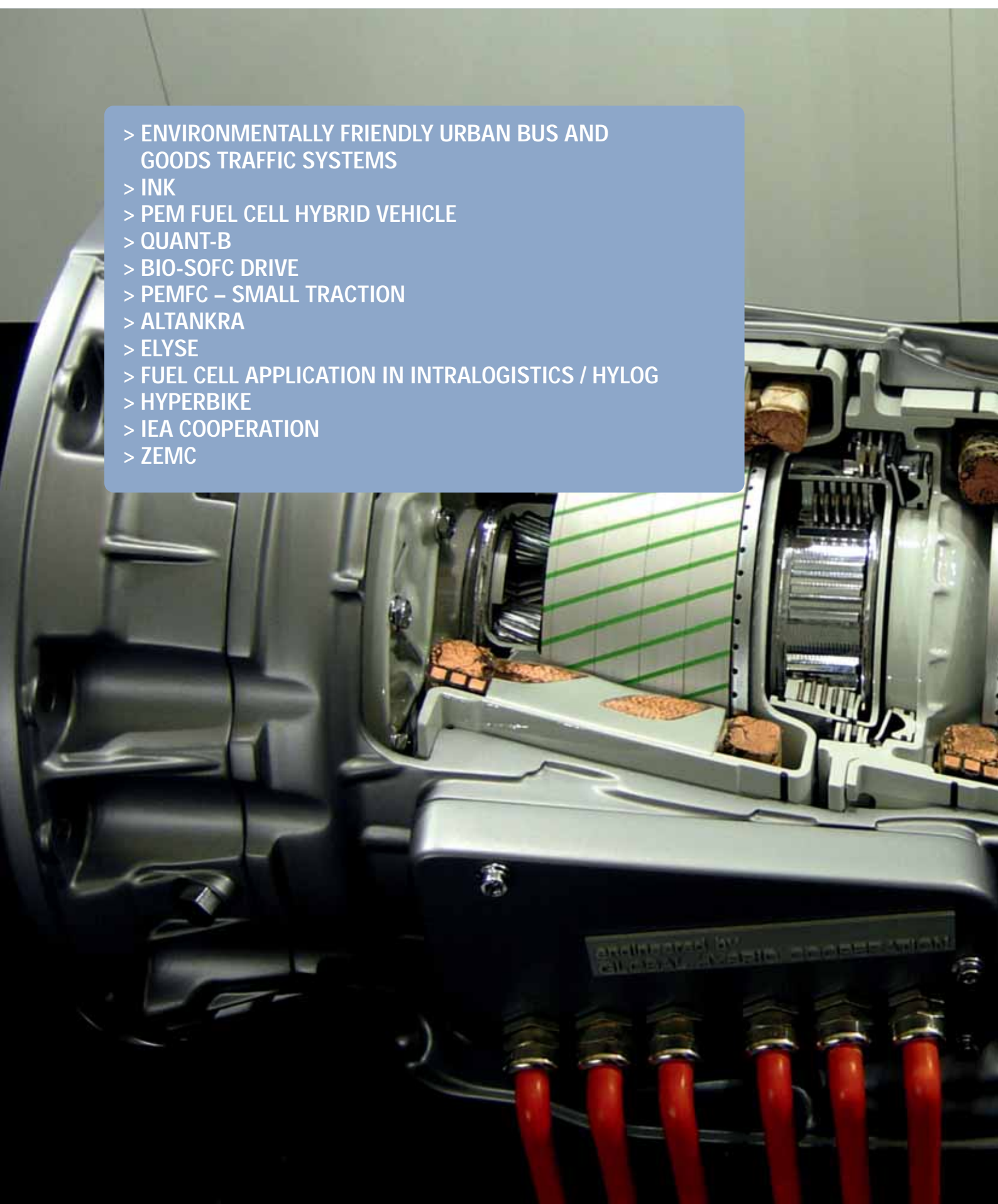

A3-PROJECTS

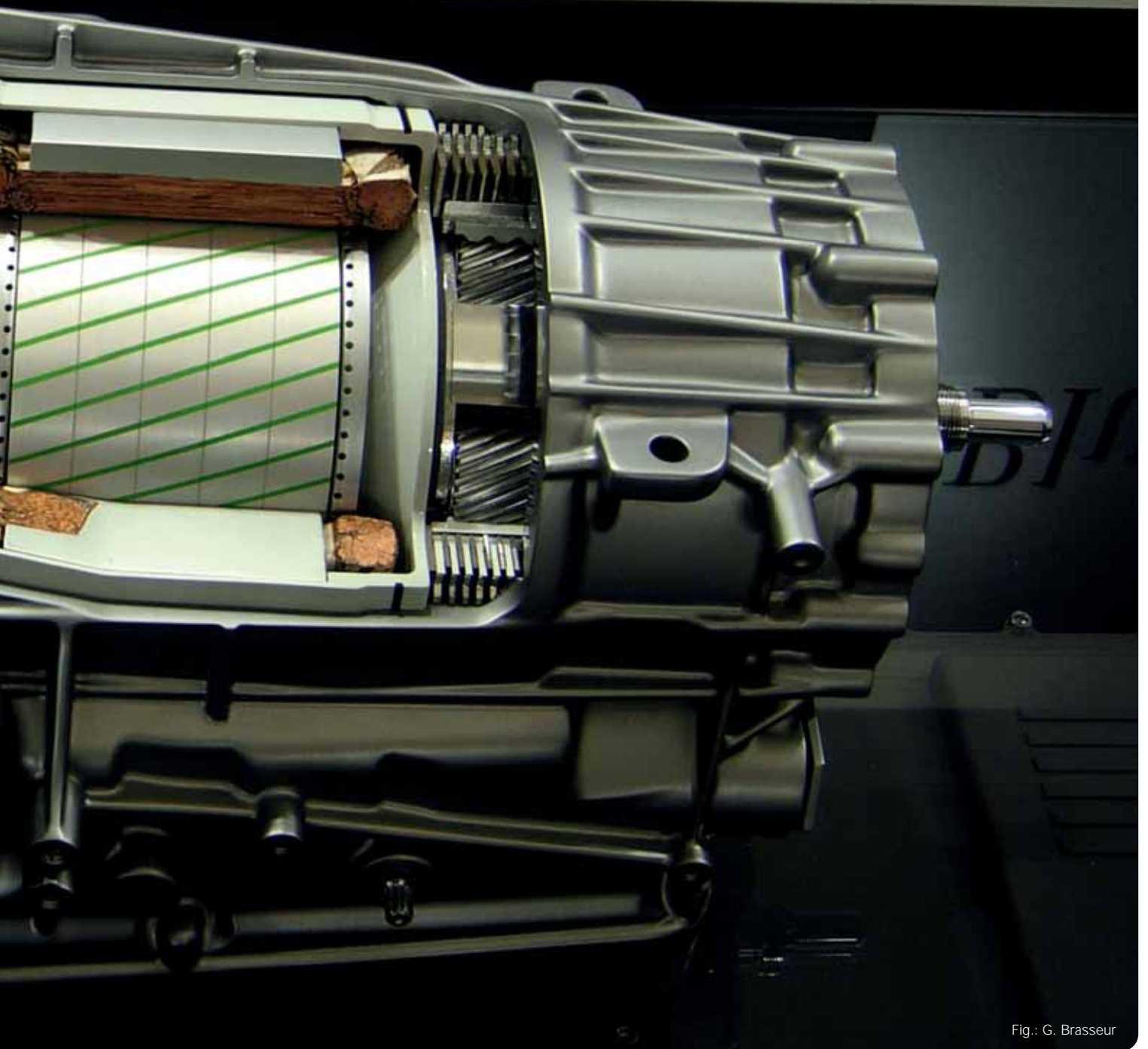

Fig.: G. Brasseur

ENVIRONMENTALLY FRIENDLY URBAN BUS AND GOODS TRAFFIC SYSTEMS

Clean fuels and zero emissions in central urban areas

The primary goal of this one-year project is to find alternative and clean solutions for urban bus and goods traffic that can be applied in the short and medium term. Reducing emissions by using alternative fuels and propulsion technologies is of primary interest.

The principal purpose of the project was to devise a concept for improving air quality in densely-populated outlying urban areas, as well as presenting different propulsion principles using alternative fuels and soft hybrid drives.

To determine the influence of bus and goods traffic on overall pollution levels, a series of measurements were conducted in May 2003 on a radial highway (Hietzinger Kai) in Vienna. With the help of these measurements, it could be demonstrated that nitrogen oxide (NO_x) emissions from heavy traffic continue to be underestimated in the technical literature.

Project management:

Vienna University of Technology – Institute for Internal Combustion Engines and Automotive Engineering

Project partners:

Wiener Linien GmbH & Co KG, ÖAMTC Academy – scientific association for mobility and environmental research

Alternative technical solutions for pollution-free propulsion concepts are proposed and discussed. Natural gas, biodiesel and alcohol fuels, as well as hybrid concepts, are examined using ecological and economic criteria. Gas-powered concepts (natural gas and liquid petroleum gas) in particular are sensible alternatives to conventionally-operated vehicles with diesel engines in the short and medium term. Given adequate geographical coverage of hydrogen refuelling stations, fuel cell technology will be a good long-term alternative because running vehicles on this technology does not cause emissions of pollutants. This is particularly attractive for inner-urban transportation.

Conversion strategies, including a market analysis, are presented for municipal authorities and fleet operators. These conversion strategies demonstrate methods to implement the proposed solutions. These strategies are intended to assist decision-makers active in the bus and goods transportation sector.

Information about the project, the project partners and links to further information can be found at the internet homepage „www.sauberer-stadtverkehr.info“.



INK

Intelligent electro-mechanical auxiliary units for motor vehicles

The aim of the project was to conduct a detailed investigation into and to optimise the efficiency of the auxiliary units and the corresponding auxiliary drives on modern motor vehicles.

One of the main project objectives was to create a progressive simulation environment for vehicle and engine manufacturers for evaluating different drive system concepts and also for reducing energy consumption in heavy goods vehicles.

A detailed digital simulation was developed in MatLab Simulink. Using this simulation, it was possible to calculate the longitudinal dynamics of a motor vehicle, taking account of the corresponding driving resistances such as air resistance, the specific resistance on an inclined track, curve resistance and rolling friction resistance. The simulation included the entire powertrain with relevant primary and secondary auxiliary units such as the water pump and the oil pump, together with the air-conditioning compressor, the air compressor and the steering booster pump. Furthermore, a control model of an electronic drive was implemented.

The simulator routine was fed with accurate real-world cycle data, taken from test rides with a heavy goods vehicle. The measurements were taken with a very high sampling rate, and also included fuel consumption. Detailed characteristic diagrams of the engine and the auxiliary units taken from test bench investigations have also been used as input data. Comparing measured and calculated fuel consumption showed a very good match when averaged over a range of driving distances, and a good match when viewed in detail.

Strategies for controlling the auxiliary units were implemented in order to realise efficiency improvements on the vehicle. The mechanical power of every individual auxiliary unit was adjusted to the power demand, regardless of the speed of the internal combustion engine. This meant that models for variable continuous drives for the auxiliary units were implemented. The size and functionality of the auxiliary units have not been changed. Using these optimised control methods, it has been calculated that there will be a two per cent improvement in fuel consumption in a fully-loaded vehicle.

Project management:

arsenal research GmbH

Project partners:

MAN Steyr AG, Vienna University of Technology – Institute for Internal Combustion Engines and Automotive Engineering, Graz University of Technology – Institute of Electrical Measurement Technology and Measured Signal Processing

POLYMER ELECTROLYTE MEMBRANE FUEL CELL VEHICLE

Polymer electrolyte membrane fuel cell vehicle

The goal of the project was to develop a fuel cell powered vehicle, which shall serve as a „technology carrier“. The project partners developed advanced components for the fuel cell system comprising essential components of the air supply sub-system, heat and water management, the hydrogen supply system and the control system.



An electric vehicle, originally powered by lead-acid batteries, formed the basis for the development of a hydrogen-powered fuel cell vehicle („zero emission vehicle“). Initially the characteristics of the battery vehicle were identified in a short-term measurement project. Based on the finding that efficiency would increase by about 8% in the European Drive Cycle (NEDC), it was decided to employ a battery hybrid fuel cell system. The previous heavy lead-acid battery pack was

replaced by an electrical power generation system consisting of a PEM fuel cell system in combination with a lighter NiMH battery pack.

The system design, development and evaluation of components, along with the vehicle modifications were carried out by the partner DLR (German Aerospace Center). AVL undertook the vehicle characterisation for the basic electrical vehicle, the higher level fuel cell vehicle control and carried out consumption and propulsion efficiency studies as well. The Christian Doppler Laboratory for Fuel Cell Systems (Graz University of Technology) developed the PEMFC as a model. Common interfaces and standards have been specified for the efficient cooperation of the individual systems in vehicles and modules, as these were developed by a number of different partners. In a parallel project in Germany, further industrial partners were integrated in the vehicle design and development.



The hydrogen powered fuel cell hybrid vehicle was successfully put into operation. The vehicle passed the first test drive in January 2005 and was officially unveiled at the „6th International Stuttgart Vehicle Symposium“ in February 2005. The project and its conclusions were presented at EVS21 (Electrical Vehicle Symposium, Monaco April 2005).

Project management:

AVL List GmbH

Project partners:

DLR – German Aerospace Center, Graz
University of Technology – Christian-Doppler
Laboratory for Fuel Cell Systems

QUANT-B

Qualification and training of teachers and skilled staff in the area of new technologies > Fuel cells and high power batteries

The next step in the project was to install a demonstration fuel cell system at ECHEM. In parallel to the theoretical background, this system provides practical training for both schools and companies, using experiments and simulations.

In the first phase, the content requirement of units of training – structured as modules – for „fuel-cell relevant“ types of schools, colleges and universities was evaluated in close cooperation with the PRO-BZ („Programme for the development of fuel cell expertise“) project. Using this information, model training programmes were prepared. The importance of each individual module was assessed depending on the needs of the different target groups in the education sector and in companies.

Different workshop concepts to implement these model training programmes were prepared for „high-performance and traction batteries“ and „fuel cell technology“.

The workshop on „high-performance and traction batteries“ gives an overview of important concepts relating to batteries and accumulators, as well as examining their technical design, the chemical processes taking place, their possible applications, and the charging/discharging techniques for the most important systems. The safety measures needed when maintaining, repairing or using battery systems are also dealt with, while an overview is given of relevant literature and (school) experiments.

The presentation of the necessary physical chemistry principles, an overview of the different types of fuel cells and their applications, as well as the historical development of fuel cells were included in the „fuel cells“ workshop documentation. General background information on the concepts of „energy“ and „electrical energy“ was also included. In the next steps, the challenges related to establishing fuel cell technology and a hydrogen infrastructure, i.e. its storage and handling, will be elaborated.

The QUANT-B project began with a needs assessment, with target groups for this assessment being the education sector in Austria (intermediate and higher-level vocational schools, secondary schools, specialist colleges and universities) and companies. The assessment identified an increasing demand for continuing education in the field of fuel cell technology. 83% of the teaching staff and 90% of the pupils questioned agreed with the need for continuing education; in the case of specialist colleges and universities, the percentages were 42% for the teaching staff and 67% for the students. At the companies, 79% of those questioned recognised the need for continuing education in the field.

Project management:

ECHEM – Center of Competence
in Applied Electrochemistry

Project partner:

Vienna University of Technology –
Institute for Chemical
Technologies and Analytic / EC
164, CATT Innovation
Management GmbH

BIO-SOFC DRIVE

Development and demonstration of a SOFC-battery hybrid drive powered by biogenous fuels

Development and fleet testing of fuel-cell battery hybrid vehicles using SOFC fuel cells and biogenous fuel. Comparison of different propulsion technologies (diesel, diesel + exhaust NO_x reduction, fuel-cell electric hybrid). Demonstration of the bio-SOFC drive in ecologically-sensitive areas of use in Austria.

The bio-SOFC (Solid Oxide Fuel Cell) drive project is investigating an innovative and environmentally-friendly vehicle drive – a fuel cell hybrid drive – in a small fleet test using several vehicle platforms. A micro-tubular SOFC fuel cell is used as a range extender for battery-powered vehicles, in order to achieve a significant improvement in the biggest weakness in electric vehicles, namely their range. The implementation of a SOFC system also makes it possible to use it as a charging device for the battery, since the micro-tubular solution has already demonstrated the necessary dynamics and cycle endurance.

An optimised battery and drive management system also improves the vehicle's propulsion system in that the greatest possible level of energy is recovered, lower fuel consumption is achieved, and the load for the fuel cell is constant. Existing electrically-powered vehicles are being supplemented with an „on-board charging device“ which continuously tops up the battery charge.

Project management:

ALPPS Fuel Cell Systems GmbH

Project partners:

arsenal research GmbH, FJ BLT Wieselburg, ÖGUT – Österreichische Gesellschaft für Umwelt und Technik, CLIMT Claassen Industrie Management Trading GmbH, ÖAMTC Österreich, MLU – Monitoring für Leben und Umwelt GmbH, Tourismusverband Werfenweng, Blaguss Reisen GmbH, Graz University of Technology – Vehicle Safety Institute

This produces the following advantages:

- > Increased vehicle range by comparison with conventional electrically-powered vehicles;
- > Waste heat from the fuel cell can be used to heat the vehicle;
- > The battery charge is topped up when travelling downhill, due to brake energy recuperation, which results in an additional fuel saving.

Biodiesel is used as the fuel, thus the test can be carried out using the existing infrastructure, including in outlying areas such as tourism-oriented communities. In addition, tests are being conducted using other biogenous fuels. Small delivery vehicles, minibuses, a boat and a measurement vehicle ensure that a qualified assessment can be made regarding practicability in a representative range of applications. Internationally, range extenders are viewed as a key future solution for the fuel cell in vehicles, since the high-temperature fuel cell makes it possible to use renewable fuels. Further investigations and analyses include user satisfaction, the effects of fuel quality, comparisons with conventional propulsion systems and general information about the benefits and applicability of the SOFC-battery hybrid drive.

Particular attention is also being paid to specialist support from independent agencies which deal with safety issues, provide training for users, assess environmental impact, etc. The project is running over two years, with the first year dedicated to the preparation of the technical solution and the second year to the operation of the vehicles. The aim is to demonstrate the suitability of this solution for practical implementation.

Development steps planned:

In a first project phase the power needs for the „Range Extender“ have been established by simulating various possible operating conditions for cars and for buses. In parallel with this, the possibilities for risk-free installation of the fuel cell have been evaluated using crash test simulation and finally a real crash test.

In a further phase, two sample vehicles will be equipped with range extenders based on IC engines. A modern exhaust treatment employing PF and DeNO_x systems will be installed to verify the principle and serve as benchmark for the fuel cell. In a later phase the ICE will be replaced by fuel cells.

PEMFC – SMALL TRACTION

Implementation of a hybrid PEMFC drive train in various small traction applications

Fuel cell technology is considered at present as one of the essential technologies of the 21st century, having regard to environmentally friendly energy supply.

Due to the cost structure of the technologies currently applied compared to that of fuel cells, the market introduction of fuel cells would, at first, be practical for applications requiring around 1 kW, for example small traction and other small mobile applications. The costs in the case of the hybrid PEMFC (Polymer Electrolyte Membrane Fuel Cell) energy supply system are relatively low, and hydrogen consumption is low, reflecting the power of the fuel cell. This also simplifies the build-up of a hydrogen infrastructure. Furthermore, small traction is an application for fuel cells which is highly visible to the general public, increasing awareness in this area.



As part of the „PEMFC – Small Traction“ project, three small traction applications will be constructed in the 1 to 3 kW range using a hybrid PEMFC energy supply system, and their functionality tested. A further contribution to the medium-term market introduction of these applications is the concept study for construction of a pilot plant to produce hybrid PEMFC energy supply systems and components; both technical and economical aspects will be examined.

The hybrid PEM fuel cell system will be tested as the energy supply system for the drivetrain in a scooter and a low floor van. In the case of the 3.5 t lightweight refrigerated vehicle, the hybrid PEM fuel cell system also supplies power to the cooling unit. Vehicles of this type are considered especially suitable for refrigerated goods delivery services in central city areas.

The first vehicle („HyCart“) with a hybrid PEM-fuel cell system was completed in September 2007. It was powered by a 1 kW fuel cell unit, two 12 V lead-acid batteries each with a capacity of 70 Ah, and a compressed hydrogen tank module for 350 bar (capacity of 0.94 kg H₂). The advantages of this system were demonstrated during testing; the range on one charge was increased three to four times (from 50 km to 200 km) and charging the hydrogen tank took only a few minutes compared with a charging time for lead-acid batteries of three to six hours. As an alternative to this configuration, metal-hydride storage systems could be implemented instead of the hydrogen tank module.

The next step for the project is a scooter powered by a fuel cell system (nominal power of the fuel cell unit: 350 to 400 W) and two metal-hydride storage units (each with a 1000 NL capacity). The energy for the cooling unit is supplied by a fuel cell with a nominal power of 1 kW and two lead-acid batteries, each with a capacity of 95 Ah. The hydrogen supply can be provided by either a 350 bar compressed hydrogen module or by a metal-hydride system. The advantages of these systems for refrigerated vehicles are the reduction of emissions, the low operating noise, and an increased level of reliability for continuity of refrigeration in the event of long standing periods during delivery services.

The aim of the „PEMFC – Small Traction“ project is to develop and produce a hybrid PEMFC (Polymer Electrolyte Membrane Fuel Cell) energy supply system with a fuel cell unit in the range of 500 W_{el} to 1 kW_{el} and to implement it in three small traction applications.

Project management:

ECHEM – Center of Competence in Applied Electrochemistry

Project partners:

Fotec Forschungs- und Technologietransfer GmbH, TMG – Technologie- und Marketinggesellschaft mbH, Photovoltaiktechnik GmbH, Fronius International GmbH, Banner GmbH, Bitter GmbH, IO Fahrzeuge Produktions- und Handels GmbH, S. Graf Carello Elektrofahrzeuge Erzeugungs- und Vertriebsgesellschaft mbH, Schuh Karosseriebau GmbH, ZSW Zentrum für Sonnenenergie- und Wasserstoff-Forschung, FuMA-Tech GmbH

ALTANKRA

Scenarios for economic feasibility of alternative propulsion systems and fuels in private transport until 2050

This study investigates if and under which conditions alternative propulsion systems and fuels will become economically relevant for private transport in Austria.

To alleviate the problems currently associated with the increase in energy demand for private motorised transport (rising consumption of fossil-based energy sources, and the associated increase in greenhouse gas emissions), further research and practical implementation projects are being pursued worldwide looking at alternative propulsion systems – hybrid drives, drives using natural gas or biogas, fuel cell vehicles, and electric drives – and new alternative energy carriers – bioethanol, biogas, biodiesel, hydrogen from renewable energy sources, synthetic fuels, electricity.

The core objective of this project is to analyse whether, under which boundary conditions, to what extent and at what point in time the aforementioned alternative propulsion systems and fuels can be of economic relevance in Austria. To achieve this objective, the impact of the following key parameters is being investigated in four scenarios:

- > Possible trends in the energy price level (low-price and high-price scenario)
- > Increases in technical efficiency and cost reductions for specific technologies;
- > Changes in policy framework conditions (taxes, subsidies, etc.).

The major conclusions of this analysis are:

Project management:

Vienna University of Technology – Institute of Electric Plant and Energy Management

Project partner:

AVL List GmbH, Joanneum Research Forschungsgesellschaft mbH

In a „business as usual“ (BaU) scenario with fuel prices for conventional fuels increasing only moderately, overall vehicle numbers increase continuously and the major effect is a strong „hybridisation“ of vehicles (figure 1). In a scenario with high oil prices and targeted introduction of „green“ policies, overall vehicle numbers stagnate or even decrease slightly, and electric as well as hydrogen-powered cars gain significant market shares from around as early as 2030 (figure 2). However, a major characteristic of all the scenarios investigated is that the diversity of propulsion systems and fuels used increases significantly.

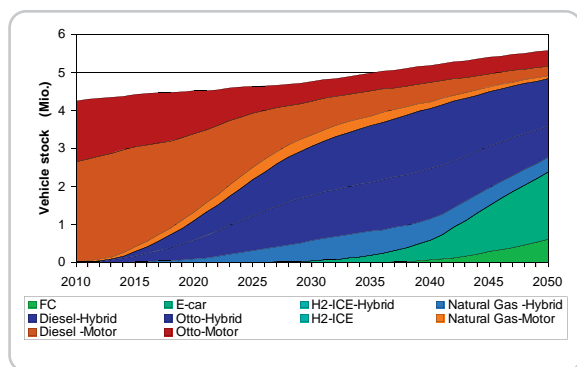

Figure 1: BaU scenario with modestly rising energy prices

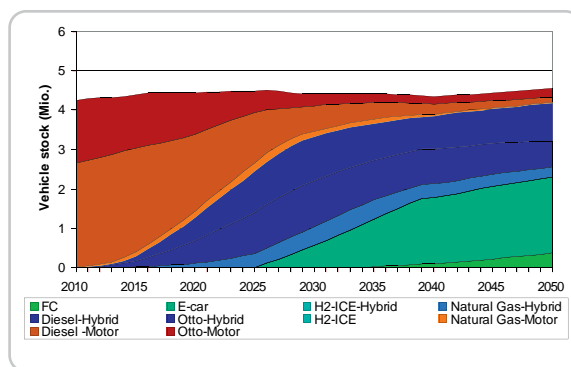

Figure 2: Scenario with clearly rising energy prices and ambitious policy measures

ELYSE

Electricity for Light duty commercial hYbrid powertrain SystEms

The operation of lightweight commercial vehicles (LD-CV) is characterised by frequent cold starting, long operation at part load and by extreme changes of load. The degree of efficiency of drives suitable for this purpose was improved through the use of direct injection diesel engines and hybrid technology (e.g. Daimler Chrysler Hybrid Sprinter). Further incremental improvements would be possible by extending the electric powered operation. Moreover, demands are being made in some parts of Europe for restricted, zero-emission equivalent road vehicle operation. The crucial issue is the limited energy storage of the battery. With a fuel cell system independent of the main drive, ultimately all electrically-operated auxiliary and support assemblies could be optimally supplied with electricity.

In the ELYSE project, the possibility of integrating a continuous fuel cell / electric energy source in lightweight commercial vehicles is examined. The fuel cell is operated using diesel reformat gas. The reformat gas shall additionally also be used to improve exhaust gas after-treatment (figure 1).

The goal of the „Electricity for Light duty commercial hYbrid powertrain SystEms - ELYSE“ project is therefore to investigate the possibilities for integrating a continuous fuel cell / electric energy source running on diesel in a lightweight commercial vehicle. A further dimension of the project is to analyse the advantages and synergies arising from these new on-board components, in terms of exhaust gas after-treatment. In particular, the current project is investigating the implementation of a high-temperature PEM (polymer electrolyte membrane) fuel cell, corresponding to the intermittent electric energy demand of a lightweight commercial vehicle. The new-type cell can be operated without gas humidification at very high anode-CO concentrations. This means it is possible to prepare the liquid hydrocarbon quite easily (fuel reformer without CO precision cleaning), and hence to use the conventional fuel (diesel or bio-diesel) from the tank of the hybrid drive. The reformat gas will additionally be used to improve exhaust gas after-treatment (particulate filter regeneration downstream of the engine). During this first year of the project, the fuel cell system structure has been investigated and defined, working together with the project partners (figure 2). Component design and component research is currently ongoing, on this basis.

Project management:
AVL List GmbH

Project partners:
Graz University of Technology – Christian-Doppler Laboratory for Fuel Cell Systems, CERTH / CPERI / APTL Greece, PEMEAS GmbH, SüdChemie Munich

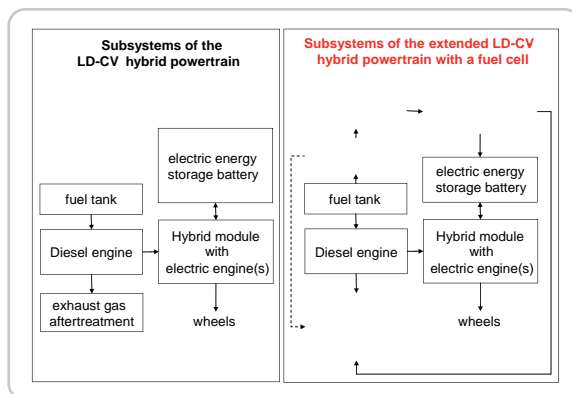

Figure 1

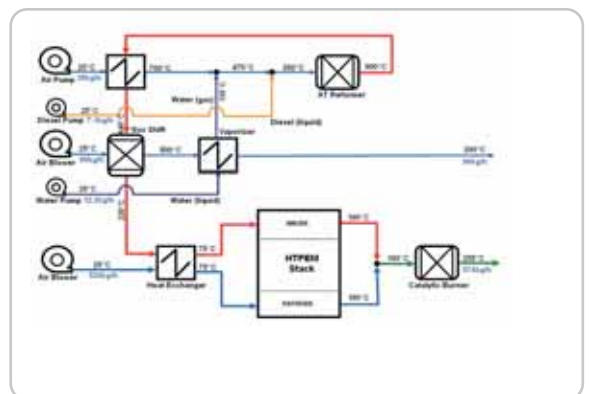

Figure 2

FUEL CELL APPLICATION IN INTRALOGISTICS / HYLOG

Demonstration of a fuel cell range-extender application for intralogistics and installation of a solar-powered hydrogen refuelling station at a European transit node in Upper Austria

The HyLOG project demonstrates and scientifically investigates the implementation of a 2.5 kW fuel cell range extender propulsion system to power an intralogistics application. The refuelling of this innovative transport solution is provided via a 350 bar compressed hydrogen cartridge system which is refilled at a hydrogen refuelling station installed on-site at the industrial facility. The hydrogen is generated by electrolysis utilising solar electricity from a 615 kW photovoltaic power plant installed on the rooftop of the factory. The HyLOG project will serve as a reference project for enhanced market entry of this zero-emission logistics solution.

The new central manufacturing and logistics facility of Fronius International is located in Sattledt, Upper Austria, adjacent to an important European transit node. The factory is a model for future energy supply on an industrial scale: solar electricity generated by a 615 kWp photovoltaic rooftop installation and heat supply via a 1.5 MW biomass plant reduces CO₂ emissions by 90%. In this context the HyLOG project addresses both, the use of renewable energy for transport applications as well as the need to develop innovative energy storage technologies.

Part of the HyLOG project was to develop and integrate a 2.5 kW fuel cell range-extender propulsion system into a tow truck used for intralogistics in the Sattledt factory. The range-extender system was designed to retrofit the lead acid traction battery used in the standard configuration of the vehicle. Compressed hydrogen provided via a 350 bar cartridge system is used for refuelling the vehicle by means of cartridge exchange. The hydrogen cartridges are refilled at the refuelling station which was installed at the production site next to the building.

The hydrogen fuel is generated on-site by electrolysis using renewable energy from a 615 kWp photovoltaic (PV) power plant installed on the rooftop of the production facility. A special research task within the HyLOG project aims to improve hydrogen generation efficiency by up to 15% through DC – direct coupling of the electrolyser and the PV generator. The potential for system standardisation and cost reduction will be investigated. Linking the installed solar-powered filling station to the European hydrogen infrastructure, presently underway will support this important initiative.



The fuel cell range-extender is potentially relevant for a broad range of different transport applications, extending from the automotive sector and industrial trucks to leisure applications (e.g. boats). Market research undertaken as part of HyLOG will help to identify scenarios for early market entry.

Project management:

Fronius International GmbH

Project partner:

Bitter GmbH, Biovest Consulting GmbH, HyCentA Research GmbH, Clusterland Oberösterreich GmbH / Automobil-Cluster



HYPERBIKE

Hybrid pedal-assisted recuperating bicycle

The HyperBike study (hybrid pedal assisted recuperating bicycle) takes up a subject which has been practically forgotten due to the low performance capabilities of earlier secondary battery types: assisting the cyclist by using an electric drive, without adding significant weight. The further development in both short-term electric storage (double-layer capacitors, high-current capability lithium polymer ion secondary batteries) and in propulsion systems (e.g. permanent-magnet synchronous motors, dual-rotor machines with axial gap, etc.) offers an opportunity to rethink the technology and/or the principle.

The study looked at concepts going far beyond current technological know-how, and applied the principle for regeneration of braking energy typical of hybrid vehicles to very small-sized energy storage units for a light two-wheeler: using these light short-term storage units means that the weight disadvantage of existing electric drive solutions can be alleviated, whilst also significantly improving range by using high-efficiency recuperation, especially in urban areas with stop & go-type operation.

The specific aims of the HyperBike project were:

- > Increasing comfort in stop & go traffic (acceleration without heavy pedalling)
- > No significant additional weight (i.e. can also be ridden without the auxiliary drive in operation)
- > Similar to a standard bicycle (no visible ballast, modern design)
- > Long service life, typical of bicycles, for all components

Optional practical functions include:

- > Integrated ABS (anti-blocking system on the drive axle)
- > Integrated LED daylight driving light (safety aspect)
- > Safe braking without wear (no influence from wet brake blocks)

Given that both the target unit weight and the high-efficiency recuperation drive system are completely new territory, the feasibility of the concept needed to be examined. In the study, this is to be achieved in part by using a simulation of the energy flows, and in part by examining the innovative, light, electrical machine for overload capacity and cooling with regard to costs.

Looking at the flow of inner-urban transport, the conclusion is reached that there are potential savings of around $\frac{1}{3}$ of the total energy used if the brake energy is regenerated in stop & go traffic. Many locally-operating fleets are operated with low maximum speeds and with frequent braking and acceleration. This includes two-wheeled vehicles (delivery vehicles), light vehicles (courier, express and parcel delivery services) and also heavy utility vehicles (waste collection and recycling vehicles), as well as rail-based transport (tram-cars).

Assessing the areas of application for the stop & go system indicated the following favourite applications:

- > Inner-company transport (between buildings)
- > Shopping/socialising
- > Assisted mobility
- > Linking to public transport (Bike&Ride, public bikes)
- > Warehouse / indoor transport
- > Vehicles for printed media and postal distribution services
- > Powered vehicles for room cleaning

Simulating stop & go operation using super-capacitors as energy storage has suggested a potential saving of at least 15%. The key factors are high-efficiency regeneration and low resistance when the regenerated energy has been spent. Optimising the electric drive resulted in a reduction in active mass of 25% compared to state-of-the-art machines. The market assessment indicated an initial market size of 37,500 bicycles with the stop & go system integrated. The potential has been evaluated at 450,000 units per year for Europe. Migrating of the stop & go technology into other pedal-assisted vehicle segments with a similar power demand is likely. Furthermore an application involving hand-guided units – such as hospital beds, trolleys etc. – is expected. The technological findings may be transferred to the automotive sector, bringing efficiency improvements.

The HyperBike study investigated assisting the cyclist inconspicuously using an electric powertrain. Given the further development in electric short-term storage units, this subject has become relevant again. In addition to this, the possible range is said to be increased significantly through energy regeneration. Possible applications scenarios for this technology in the automotive sector are being analysed.

Project management:

Austrian Mobility Research –
FGM – AMOR gemeinnützige
GmbH

Project partners:

University of Leoben – Institute
for Electrical Engineering,
DanklHampel Design



IEA COOPERATION

International networking in the field of alternative propulsion technology

The aim of the activities was to intensify international contacts, identify further opportunities for cooperation, and strengthen the Austrian position in the field of alternative propulsion technologies within the International Energy Agency (IEA) network. Additional measures for knowledge transfer and awareness-raising within the Austrian research and industry have been taken.

The participation of Austrian industry and research in European and international networks in the field of alternative drive technologies is essential to position Austrian competences internationally and to strengthen its competitiveness. This networking is necessary on the one hand to implement new technologies quickly and efficiently, and create marketable products. On the other hand, the positioning of alternative drive technologies itself calls for coordinated international efforts. As one of the key players for energy-related issues, the International Energy Agency (IEA) provides a platform aiming at securing information exchange and developing measures and recommendations for future research projects, including the area of research covering alternative vehicle concepts.

Within the IEA, one of its cooperation agreements (implementing agreements) is dedicated to „hybrid & electric vehicles“. Under this framework, various technological and market-oriented aspects of alternative drive technologies are discussed and elaborated at expert level. The projects (Annexes) currently running under this implementing agreement include the areas of hybrid vehicles, electric two-wheeled vehicles and electrochemical energy storage. Participation in these Annexes thus allows on the one hand for active involvement in framing these issues, and on the other hand for positioning national competences and activities in the international context.

The IEA cooperation project accordingly focused on collaboration in these Annexes, on integrating new players into these research areas and on knowledge transfer and awareness-raising within the Austrian automotive industry and research landscape.

The participation of the project partners in the Annexes for „hybrid vehicles“, „energy storage“ and „electric two-wheelers“ comprised technological investigations, market analysis and industry impact assessments. International conferences and meetings of experts have been used to evaluate the state-of-the-art and devise recommendations for policy, industry and research. New players have become involved in broadening the network, as organisations that are currently looking to expand their activities in the new market of alternative vehicles and its components.

Project management:

arsenal research GmbH

Project partners:

Graz University of Technology –
Institute for Chemical Technology of
Inorganic Materials, Automotive
Cluster Vienna Region
Wirtschaft.Raum.Entwicklung.GmbH

In terms of networking on a national level and information exchange on current research projects, a conference was organised on „Hybrid & electric vehicles – chances for the Austrian automotive industry“. Keynote speakers from the Austrian and European industry and policy entities, together with technical presentations on the latest Austrian research findings on energy storage, alternative vehicle concepts and innovative development tools, facilitated an intensive information exchange within the Austrian automotive R&D community.



ZEMC

Development of a Zero-Emission Motorcycle

The aim of the project was to develop a pure electric motorcycle to demonstrate the potential of electric propulsion for high-performance applications, and to use this prototype as the basis for future road applications. To realise an electric motorcycle with comparable driving characteristics to conventional ones, the electric drive has to combine the highest performance with the lowest weight and volume. Key issues in the development process were therefore the development of a high-efficiency, compact and intelligent electric drive, a safety concept, and the packaging of the new components into a newly-designed motorcycle frame.

A systems-level simulation was essential for designing optimised electric drive components. A vehicle model was set up containing all the relevant mechanical and electrical components. Real off-road driving cycles have been used in addition to standardised ones to analyse the requirements for the different components. 1,200 hours have been driven with the virtual vehicle in around 25 hours of simulation time, giving comprehensive information on component requirements without any prototyping. Using this vehicle simulation, the optimal size and power of the electric machine and battery module has been determined to allow for the highest performance.

Based on these simulation results and comprehensive evaluation data for a wide spectrum of lithium ion batteries on the test bed, the optimal battery has been selected and the battery management developed. Since lithium ion batteries were used, a balancing concept was required. Strong emphasis was placed on realising a balancing system and battery management allowing for the highest safety and power at the lowest weight and volume. The same requirements have been applied for the electric machine design process. The electric machine was designed with consideration being given to the electrical and thermal behaviour, resulting in a compact and small electric machine with suitable overload characteristics. The design process for the different components, electric machine, power electronics and battery package was strongly linked with the overall motorcycle package. Optimal use of the available space and appropriate layout of the components were required to combine performance and design.

Since the electric drive operates at high voltage levels, a safety concept was required which was realised at the hardware and software level. Particular emphasis was given to protecting the battery system mechanically and to designing the battery package in a way to ensure safe handling of the battery under normal conditions and maximum safety in case of accidents. In addition, the vehicle management strategy comprises a comprehensive safety protocol during starting and monitoring of all safety-critical parameters during driving.

Prior to vehicle integration the electric drive was tested on the test beds at arsenal research. Finally the components were integrated into the new motorcycle frame and real driving tests were performed, validating the simulation results and demonstrating that high-performance electric vehicles can be realised using today's existing technologies. The project's results therefore clearly indicate the potential of electric propulsion for high-performance applications and provide a sophisticated basis for realising competitive electric vehicles for different market segments.

By developing a high-performance, pure electric motorcycle, it was possible to demonstrate the potential of electric vehicles, including for off-road and sports applications. In that context, special emphasis has been given to realising a high efficiency, compact and intelligent electric drive based on the latest battery technologies. The results indicate that competitive products can be realised using technologies which already exist, opening up new areas of application and target groups.

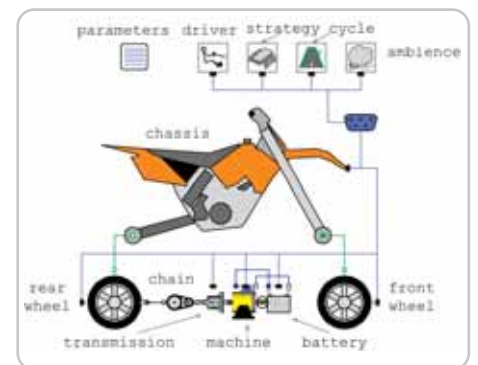

Project management:

KTM Sportmotorcycle AG

Project partners:

arsenal research GmbH,

Kiska GmbH

- 
- > AUSTRIAN ELECTRIC VEHICLE ROAD MAP
 - > ELEK-TRA
 - > ENPORTER
 - > EVT-DRIVETRAIN
 - > HELIOSTAR
 - > HYBRID WHEEL LOADER
 - > HYCART
 - > „KLIMA MOBIL“ – AIR QUALITY PLUS MOBILITY

A3plus-PROJECTS

The success of the A3 Programme „Austrian Advanced Automotive Technology“ which ran from 2002 to 2006 was the basis for the BMVIT’s decision to pursue its R&D funding activities with the successor A3plus Programme from 2007 onwards. While A3 covered alternative propulsion systems and fuels, together with other aspects of automotive research such as materials development for safe and lightweight structures, electronic and telematic components or noise reduction, the subsequent programme A3plus is focusing on clean and energy-efficient alternative technologies for the powertrain, and including other modes of transport in addition to road vehicles.

The increasing importance of hybrid and electric vehicles, energy storage technologies and electronic control systems is reflected in the response to the calls for proposals. The total of 4 calls for A3 proposals and 2 calls for Lighthouse projects resulted in the 12 projects covering these areas and presented in the preceding pages; whereas the first call for proposals in the A3plus Programme alone resulted in 8 projects in this field and selected in 2007.

The following section presents these eight projects, which cover a wide range of areas: freight and passenger transport, lightweight vehicles and working machines, two- and three-wheeler vehicles for regional delivery services, zero emissions vehicles in local public transport, electrical-mechanical power distribution transmission, battery/fuel cell hybrid vehicles with decentralised hydrogen infrastructure, use of renewable energy sources, analysis of the market potential of electric vehicles, creating supportive ecological, environmental policy and technical framework conditions, and developing scenarios to investigate the effectiveness of different policy instruments.

Fig.: G. Brasseur

AUSTRIAN ELECTRIC VEHICLE ROAD MAP

QUO VADIS ELECTRIC CAR? –

PROSPECTS FOR A DEMONSTRATION VEHICLE FLEET AS PART OF AN AUSTRIAN ROAD MAP FOR BATTERY-POWERED ELECTRIC VEHICLES

Applicant:

JOANNEUM Research
Forschungsgesellschaft mbH

Short-term and medium-term market potential for energy-efficient and environmentally-friendly battery-powered electric vehicles is demonstrated using technical, economic and ecological analyses, based on present and future user requirements and expectations from attractive types of application. The central focus is on developing perspectives for the relevant vehicle industry and for the electricity generating industry, so as to initiate an Austrian demonstration vehicle fleet and accelerate its market launch through innovative approaches.

ELEK-TRA

DEVELOPMENT OF SCENARIOS FOR THE SPREAD OF VEHICLES WITH PARTLY AND FULLY ELECTRIC DRIVETRAINS UNDER VARIOUS POLICY FRAMEWORK CONDITIONS

Applicant:

Vienna University of Technology –
Institute for Electric Plant and
Energy Management

Dynamic profitability analysis of partly and fully-electric drivetrain systems for vehicles, taking account of ecological, eco-political and technical framework conditions. The project looks to develop scenarios to investigate the effectiveness of different policy instruments on the spread of partly and fully-electric drivetrain systems.

ENPORTER

ELECTRIC DRIVE FOR AN INCLINING CHARGE WHEEL FOR POSTAL AND REGIONAL DELIVERY SERVICES

Applicant:

REBIKEL

The advantages of the two-wheeler are to be combined with those of the three-wheeler, in order to provide – for example – postal delivery services with an Austrian-produced vehicle where the electric drive overcompensates the additional weight of the inclined construction, making it possible to extend the practicable range (and thus productivity) at a reasonable vehicle cost.

EVT-DRIVETRAIN

DRIVE TRAIN WITH ELECTRICAL-MECHANICAL POWER DISTRIBUTION TRANSMISSION

Applicant:

HOFER Forschungs- und
Entwicklungs GmbH & Co KG

The goal is the development of an infinitely variable drive system with electrical-mechanical power distribution in the 35 – 80 kW performance range, and to demonstrate the concept using an ATV. Using this prototype model, the aim is to demonstrate reductions in fuel consumption and emissions by 20-30% compared with conventional vehicles, whilst satisfying the highest requirements in terms of comfort.

HELIOSTAR

ULTRA-EFFICIENT, LIGHT, INTEGRATABLE SOLAR MODULES TO REDUCE FUEL CONSUMPTION AND EXHAUST EMISSIONS OF HYBRID ELECTRIC VEHICLES

Applicant:
SUNPLUGGED GmbH

This concept initiative includes development of a roof panel prototype for installation on truck bodies, with integrated high-performance PV modules. The PV modules perform all the functions of a conventional roof panel, whilst additionally providing electrical power for on-board power supply and for supporting accessory units.

HYBRID WHEEL LOADER

CONCEPT DEVELOPMENT OF HYBRID DRIVES FOR MOBILE WORKING MACHINES, USING THE WHEEL LOADER AS AN EXAMPLE

Applicant:
LIEBHERR-Werk Bischofshofen GmbH

Hybrid drive concepts for mobile working machines are to be evaluated using a wheel loader as an example, to develop a technologically-optimised and cost-optimised hybrid concept which reduces energy consumption by at least 15 %. As a starting point, a hybrid version of the Hofer VDC (Variable Double Clutch) drive is being developed and compared with alternative hybrid concepts using simulation studies.

HYCART

USE OF FUEL CELL VEHICLES WITH DECENTRALISED HYDROGEN INFRASTRUCTURE UNDER REAL CONDITIONS TO ACHIEVE MATURITY FOR SERIES MANUFACTURE

Applicant:
ECHEM – Center of Competence in Applied Electrochemistry

The aim is to devise a total solution for using battery/fuel cell hybrid vehicles for company-internal applications. This includes hydrogen storage and various technical options for developing a decentralised hydrogen infrastructure. By operating battery/fuel cell vehicles under real conditions, the knowledge needed for series use is being acquired.

„KLIMA MOBIL“ – AIR QUALITY PLUS MOBILITY

ZERO EMISSIONS VEHICLES IN LOCAL PUBLIC TRANSPORT

Applicant:
Filmarchiv Austria

Series-produced city buses from an Austrian manufacturer are being converted to electric vehicles with innovative battery/energy storage systems and undergoing a practical trial as part of local public transport provision (local buses and dial-up shared taxis) in two Austrian model communities. The objective is small series production with concrete prospects for marketing.

- > HI-CEPS
- > HYSYS



EU-PROJECTS

The European Union supports research and development on hybrid and electric vehicles through its R&D Framework Programmes. Following strong interest in these technologies in the 1980s and 1990s, their economic failure in the market due to limited user acceptance was a sobering experience for the industry. This disillusion led to a reduction in R&D activities by European industry and research institutions at the beginning of this decade. As a consequence, only two projects with Austrian partners looking at these topics have been realised under EU Framework Programme 6.

Improved battery technologies, and sophisticated energy and power management using improved control electronics, have paved the way for the economic success of hybrid vehicles in recent years. This has led to a sharp increase in R&D efforts and industrial investment in electric and hybrid vehicle technologies. With the launch of the EU Framework Programme 7, the electric drivetrain has become a far greater focus of interest and of R&D activities.

Nevertheless, the European Commission decided to wait for the results from the projects running under Framework Programme 6 before opening the call in Framework Programme 7 (FP 7) for new hybrid and electric vehicle projects. Accordingly, these areas were not included in the first FP 7 call for proposals, but were open for submissions under the second FP 7 call. Several Austrian research institutions with electric and hybrid vehicle projects participated in this second FP 7 call. As the evaluation of this call was not concluded before this brochure went to press (end of September 2008), the following pages present projects from the preceding Framework Programme 6.

HI-CEPS

Highly-Integrated Combustion Electric Propulsion System

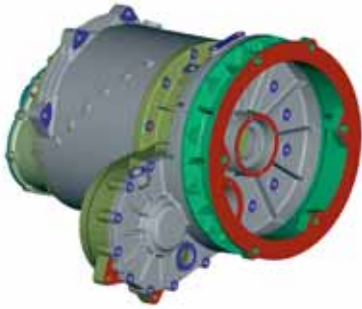

The objective of Hi-Ceps is the development of three different, innovative series-parallel full hybrid electric powertrains adopting low-cost and standardised common powertrain electric devices, auxiliary vehicle systems and dedicated gasoline, diesel and natural gas internal combustion engines with after-treatment systems for hybrids, and capable of being adjusted for future fuels.

In terms of vehicle performance, Hi-Ceps will match performance on environmentally-friendly issues (fuel consumption, reduction in CO₂ and regulated noxious emissions) with fun-to-drive characteristics (enhanced transient performance, driveability & comfort), at an acceptable purchase price/running costs (perceived value).

GOALS:

Optimising advanced hybrid vehicle concepts for vehicles which can be mass-produced on the European market, based on cost-competitive, highly-integrated thermal-electric hybrid powertrain architectures:

- Low-cost and standardised common hybrid powertrain electric devices
- Innovative vehicle and powertrain auxiliaries (electric after-treatment, vehicle heating, cooling and air conditioning) to enable optimisation of the entire electric and thermal energy flows
- Dedicated internal combustion engines for full hybrid applications (gas engine), capable of being adjusted for future fuels

Austrian partners:
AVL List GmbH

PROJECT INFORMATION:

- Project Name: Highly-Integrated Combustion Electric Propulsion System
- Duration: 01.09.2006 – 31.08.2010
- Coordinator: Centro Ricerche Fiat
- Total budget: □ 19.32 million
- EC funding: □ 9.88 million
- Partners: 23 (4 OEMs, 5 suppliers, 6 engineering and RTD companies, 3 research organisations, 6 university institutes).
- Countries: 10 EC Member States and Switzerland

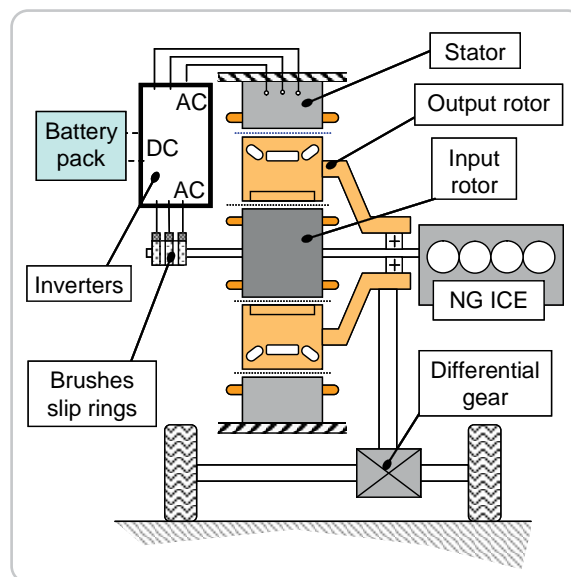

HYSYS

Fuel Cell Hybrid Vehicle System Component Development

The goal of the project is to research low-cost components for fuel cell (FC) systems and electric drive systems which can be used in future hybridised FC vehicles (as a medium-term objective) and in ICE vehicles. The components will be analysed and tested in two FC vehicle platforms with different concepts.

The focus of the project is on components with high potential for significant cost reductions by decreasing complexity and/or on choosing innovative approaches to support future mass production. In the area of FC system components, the key components being investigated are innovative air supply based on electric turbochargers, innovative humidification subsystems, new hydrogen sensors and innovative hydrogen injection system components. For the electric drive system, we focus on highly integrated drivetrains (converters, inverters and electrical motors) and high energy density battery systems based on innovative Li-Ion technology which has been developed in EU funded projects (EV-lift, Lionheart).

All the component work is accompanied by a sub-project which will work on the requirements for vehicles, subsystems and components, standardisation of components, identification of synergies between components for FC and ICE Hybrids, safety aspects and a comparative investigation of different electrical storage systems (battery / supercap) and the respective e-storage management. In the system level subproject, as well as integrating and testing the components in the two validation vehicles, work will also be directed towards optimised vehicle control strategies, energy management and development of modular system control software.

GOALS:

- Improving fuel cell system components for market readiness
- Improving electric drivetrain components (synergies between FC and ICE hybrids) for market readiness
- Optimising the system architecture for low energy consumption, high performance, high durability and reliability
- Optimising energy management
- Developing low-cost components for mass production
- Validating component and system performance on FC vehicles

PROJECT INFORMATION:

- Project name: Fuel Cell Hybrid Vehicle System Component Development
- Duration: 01.12.2005 – 30.11.2009
- Coordinator: Daimler AG
- Total budget: □ 22.7 million
- EC funding: □ 11.2 million
- Partners: 25 (14 industry, 2 SMEs, 4 institutes, 5 universities)
- Countries: 8 EC Member States and Switzerland
- Website: <http://www.hsys.eu>

Austrian partners:

AVL List GmbH



E-motor (CRF-Selin Sistemi)

AUSTRIAN INSTITUTIONS IN THE FIELD OF HYBRID AND ELECTRIC VEHICLES

ALPPS Fuel Cell Systems GmbH	www.alpps.at
Arsenal Research GmbH	www.arsenal.ac.at
Austrian Mobility Research – FGM – AMOR gemeinnützige GmbH	www.fgm.at
Automotive Cluster Vienna Region Wirtschaft.Raum.Entwicklung.GmbH	www.acvr.at
AVL List GmbH	www.avl.com
Banner GmbH	www.bannerbatterien.com
Biovest Consulting GmbH	franz.leichtfried@biovest.at
Bitter GmbH	www.bitter.at
Blaguss Reisen GmbH	www.blaguss.com
CATT Innovation Management GmbH	www.catt.at
CLIMT Claassen Industrie Management Trading GmbH	www.climt.at
Clusterland Oberösterreich GmbH / Automobil-Cluster	www.automobil-cluster.at
DanklHampel Design	www.danklhampel.com
ECHEM – Center of Competence in Applied Electrochemistry	www.echem.at
Filmarchiv Austria	www.filmarchiv.at
FJ BLT Wieselburg	blt.josephinum.at
Fotec Forschungs- und Technologietransfer GmbH	www.fotec.at
Fronius International GmbH	www.fronius.com
FuMA-Tech GmbH	www.fumatech.com
Graz University of Technology – Christian-Doppler Laboratory for Fuel Cell Systems	www.fuelcells.tugraz.at
Graz University of Technology – Institute for Chemical Technology of Inorganic Materials	www.ictas.tugraz.at
Graz University of Technology – Institute of Electrical Measurement Technology and Measured Signal Processing	www.emt.tu-graz.ac.at
Graz University of Technology – Vehicle Safety Institute	www.vsi.tugraz.at
HyCentA Research GmbH	www.hycenta.tugraz.at
IO Fahrzeuge Produktions- und Handels GmbH	www.io-scooter.com
Joanneum Research Forschungsgesellschaft mbH	www.joanneum.at
Kiska GmbH	www.kiska.at
KTM Sportmotorcycle AG	www.ktm.at
Liebherr – Werk Bischofshofen GmbH	www.liebherr.at
MAN Steyr AG	www.man-steyr.at
MLU – Monitoring für Leben und Umwelt GmbH	www.mlu.at
ÖAMTC Academy – scientific association for mobility and environmental research	www.oeamtc.at/akademie
ÖAMTC Österreich	www.oeamtc.at
ÖGUT – Österreichische Gesellschaft für Umwelt und Technik	www.oegut.at
PEMEAS GmbH	www.pemeas.com
Photovoltaiktechnik GmbH	www.pvt-austria.at
Rebikel	
S. Graf Carello Elektrofahrzeuge Erzeugungs- und Vertriebsgesellschaft mbH	www.graf-carello.com
Schuh Karosseriebau GmbH	www.schuh.co.at
SüdChemie Munich	www.sud-chemie.com
Sunplugged GmbH	
Tourismusverband Werfenweng	www.werfenweng.org
University of Leoben – Institute for Electrical Engineering	www.unileoben.ac.at
Vienna University of Technology – Institute for Chemical Technologies and Analytic	institute/etechnik.htm
Vienna University of Technology – Institute for Internal Combustion Engines and Automotive Engineering	www.cta.tuwien.ac.at
Vienna University of Technology – Institute of Electric Plant and Energy Management	www.ivk.tuwien.ac.at
Wiener Linien GmbH & Co KG	www.ea.tuwien.ac.at www.wienerlinien.at

CONTACTS AND INFORMATION

OVERALL RESPONSIBILITY

Austrian Federal Ministry for Transport, Innovation and Technology
Unit for Mobility and Transport Technologies
A-1010 Vienna, Renngasse 5
www.bmvit.gv.at
Evelinde Grassegger
e: evelinde.grassegger@bmvit.gv.at, t: +43-(0)1-711 62-65 3106

Programme Line A3plus
www.A3plus.at
Christian Drakulic
e: christian.drakulic@bmvit.gv.at, t: +43-(0)1-711 62-65 3212

PROGRAMME MANAGEMENT AND FUNDING ADMINISTRATION (IV2S, IV2Splus)

Austrian Research Promotion Agency
Thematic Programmes Section
A-1090 Vienna, Sensengasse 1
www.ffg.at

Programme Management – IV2Splus
Christian Pecharda
e: christian.pecharda@ffg.at, t: +43-(0)5 77 55-5030

Programme Line A3plus
Thomas Uitz
e: thomas.uitz@ffg.at, t: +43-(0)5 77 55-5032

